

May

Recording	\$	<u>469⁰⁰</u>
Doc Stamps	\$	<u>0</u>
Intangible Tax	\$	<u>0</u>
Total	\$	<u>469⁰⁰</u>

RECORDED IN OFFICIAL RECORDS
 INSTRUMENT # 2336778 55 PGS
 2007 MAY 09 03:09 PM BK 3596 PG 1053
 J. K. "BUDDY" IRBY
 CLERK OF CIRCUIT COURT
 ALACHUA COUNTY, FLORIDA
 CLERK13 Receipt#329592

RETURN TO:
SFMH&M

This instrument prepared by:
 Melissa Jay Murphy, Esq.
 Salter, Feiber, Murphy,
 Hutson & Menet, P.A.
 P.O. Box 357399
 Gainesville, FL 32635
 PH: (352) 376-8201



DECLARATION OF CONDOMINIUM

OF

BUILDING 3, METRO 39 OFFICE PARK CONDOMINIUM

ARTICLE I

PREAMBLE, NAME AND LEGAL DESCRIPTION

The undersigned, **HOWE DEVELOPMENT CORPORATION**, a Florida Corporation, whose address is 3940 NW 16th Blvd., Building A, Gainesville, FL 32605, ("Developer"), being the holder of fee simple title to that certain real property located in Alachua County, Florida, and more particularly described hereinafter, does hereby submit such lands as described in Paragraph 1.2 below together with the improvements thereon to the condominium form of ownership in accordance with the provisions of Chapter 718, Florida Statutes, and the following provisions:

1.1. Name. The name by which this condominium is to be identified is **BUILDING 3, METRO 39 OFFICE PARK CONDOMINIUM** (the "Condominium").

1.2. Legal Description. Developer is the owner of that certain real property located in Alachua County, Florida, more particularly described in the attached **Exhibit "A"**, which exhibit is incorporated herein by this reference. The property that is hereby submitted to the condominium form of ownership under this Declaration of Condominium consists of that certain real property set forth in the attached Exhibit "A" together with those easements more specifically and particularly described in Article V herein.

ARTICLE II
DEFINITIONS

The terms used in this Declaration and in its exhibits, including the Articles of Incorporation and Bylaws of the Association, shall be defined in accordance with the provisions of Chapter 718 and as follows unless the context otherwise requires:

2.1 Ad Valorem Real Estate Taxes shall mean those real property taxes assessed against the Units and their respective undivided interests in the Common Elements by Alachua County, Florida.

2.2 Articles of Incorporation shall mean the Articles of Incorporation of the Association, as they may be amended from time to time. A copy of the present Articles of Incorporation are attached hereto as **Exhibit "B"** and incorporated herein by reference.

2.3 Association shall mean Building 3, Metro 39 Office Park Condominium Association, Inc., a non-profit Florida corporation, and its successors, which is responsible for the operation of the Condominium.

2.4 Association Property shall mean any real and personal property owned by the Association including, but not limited to, all furnishings, fixtures and other personal property contained within the Condominium Property that are not the property of an individual Owner.

2.5 Bylaws shall mean the Bylaws of the Association as they may be amended from time to time. A copy of the present Bylaws are attached hereto as **Exhibit "C"** and are incorporated herein by this reference.

2.6 Chapter 718 shall mean the provisions of Chapter 718, Florida Statutes, as the same is constituted on the date of the recording of this Declaration.

2.7 Common Elements shall mean all of those items defined in Chapter 718 as Common Elements and those items hereinafter declared to be included within the Common Elements.

2.8 Common Expenses shall include:

- A. Expenses of administration and management of the Condominium Property and of the Association including, but not limited to, compensation paid by the Association to a manager, accountant, attorney or other employee or independent contractor.
- B. Expenses of maintenance, operation, repair and replacement of the Common Elements and Limited Common Elements, as well as all other costs and expenses properly incurred by the Association.
- C. Expenses declared Common Expenses by the provisions of this Declaration or the Condominium Documents or Chapter 718.
- D. Any valid charge against the Condominium Property as a whole.
- E. All costs and expenses incurred by the Association in connection with regulatory compliance.
- F. All reserves for replacement and maintenance of the Condominium Property as required by Chapter 718.

Common Expenses shall not include Ad Valorem Real Estate Taxes assessed against each Condominium Parcel but shall include any and all taxes assessed against Association Property.

2.9 Common Surplus shall mean any excess of all receipts of the Association over the amount of Common Expenses.

2.10 Condominium shall mean and refer to BUILDING 3, METRO 39 OFFICE PARK CONDOMINIUM.

2.11 Condominium Documents shall include this Declaration, together with all exhibits attached hereto and all other documents expressly incorporated herein by reference, as the same may be amended from time to time.

2.12 Condominium Parcel is a Unit, together with the undivided share in the Common Elements and Common Surplus which are appurtenant to the Unit.

2.13 Condominium Property means and includes the lands, leaseholds, easements and personal property including, but not limited to, the Common Elements that are subjected to condominium ownership from time to time as part of this Condominium, whether or not contiguous, and all improvements thereon and all easements and rights appurtenant thereto intended for use in connection with this Condominium.

2.14 Condominium Rules and Regulations shall mean and refer to the rules and regulations concerning the use of Condominium Property as may be promulgated and amended from time to time by the Board of Directors of the Association.

2.15 Declaration shall mean this Declaration of Condominium of BUILDING 3, METRO 39 OFFICE PARK CONDOMINIUM, as it may lawfully be amended from time to time, pursuant to the provisions hereof.

2.16 Developer shall mean Howe Development Corporation, a Florida Corporation, its successors and assigns. No party other than Howe Development Corporation shall exercise the rights and privileges reserved herein to the Developer unless such party shall receive and record in the Public Records of Alachua County, Florida, a written assignment from the Developer of all or a portion of such rights and privileges.

2.17 Limited Common Elements means and includes those Common Elements which are reserved for the use of a certain Unit to the exclusion of other Units.

2.18 Master Declaration shall mean and refer to the Declaration of Covenants, Conditions and Restrictions for Metro 39 Office Park, dated March 30, 2007 and recorded in OR Book 3574, page 1375 of the Public Records of Alachua County, Florida, as the same may have been and may be amended from time to time.

2.18 Mortgagee shall mean the Developer (and any successor-in-interest to the Developer as to a purchase-money mortgage), the Federal National Mortgage Association (FNMA), the Federal Home Loan Mortgage Corporation (FHLMC), or any trust, savings and loan association, credit union, mortgage company, bank, insurance company, or commercial loan company licensed to do business in the State of Florida, to the extent that any of the same hold a first mortgage encumbering any Unit.

2.19 Owner means the owner of a Unit, as evidenced by a recorded deed of conveyance.

2.20 Unit means a condominium unit as that term is defined in Chapter 718 and in Article VI of this Declaration and refers to that part of the Condominium Property which is subject to exclusive ownership by one or more persons.

2.21 Utility Services shall include, but not be limited to, electric power, cable television, water, garbage and sewage disposal and telephone service, and all other public service and convenience facilities.

ARTICLE III
DEVELOPMENT DESCRIPTION

3.1 Description. This is a commercial condominium. The Condominium will consist of one (1) one-story building, containing 5 units.

The legal description and site plan for the Condominium Property is more fully set forth in the attached composite Exhibit A.

Time-share estates will not be created with respect to units in the Condominium.

3.2 Ownership of Common Elements and Common Surplus and Share of Common Expenses. The ownership of Common Elements and Common Surplus and the share of Common Expenses attributable to each Unit are based on the percentage that the square footage of the Unit bears to the total square footage of all Units as set forth below. For purposes of this Article 3.2, the total square footage contained in all Units is 6452 as measured from exterior walls. The square footage of each Unit and the resulting percentage share of Common Elements and Surplus and Share of Common Expenses are set forth below:

<u>Unit</u>	<u>Square Footage of Unit</u>	<u>Share of Common Elements and Surplus and Share of Common Expenses</u>
A	1944	30.2%
B	1282	19.8%
C	1282	19.8%
D	1944	30.2%
Totals	6452	100%

The measurements shown on composite Exhibit "A" depict interior square footage as is required by Chapter 718.

ARTICLE IV
EXHIBITS

The Exhibits referred to in this Declaration shall include the following:

4.1 Exhibit "A". A legal description and a survey of the land committed to the condominium form of ownership pursuant to this Declaration and comprising the Condominium Property, together with a graphic description of the Units located therein in a plot plan which, together with this Declaration, are of sufficient detail to identify the Common Elements and each Unit and their relative locations and approximate dimensions. As set forth in Exhibit "A", each Unit is identified by a building number and letter so that no Unit bears the same designation as any other Unit.

Exhibit A-1	Legal description of the condominium
Exhibit A-2	Plot plan and Unit Designations
Exhibit A-3	Floor plans
Exhibit A-4	Floor plan for Unit A
Exhibit A-5	Floor plan for Unit B
Exhibit A-6	Floor plan for Unit C
Exhibit A-7	Floor plan for Unit D

Copies of the survey are also recorded in Condominium Book 9, pages 68-73, of the Public Records of Alachua County, Florida.

4.2 **Exhibit "B"**. The Articles of Incorporation of the Association.

4.3 **Exhibit "C"**. The Bylaws of the Association.

ARTICLE V **EASEMENTS**

The following easements are hereby expressly reserved or have been granted:

5.1 **General Easements**. Non-exclusive easements over, across and under the Condominium Property are expressly provided for and reserved in favor of the Developer and the Owners and their respective lessees, guests and invitees as follows:

A. **Utilities**. Easements are reserved over, across and under the Condominium Property as may be required for Utility Service in order to serve the Condominium adequately; including, but not limited to, easements for the purpose of allowing such access rights as are necessary to utilize and service any lift station or utility transformer boxes located within the Condominium Property.

B. **Encroachments**. In the event that any Unit shall encroach upon any of the Common Elements or upon any other Unit, or in the event any Common Element shall encroach upon any Unit, then an easement shall exist to permit such encroachment so long as the same shall exist.

C. **Traffic**. An easement shall exist for pedestrian traffic over, through and across sidewalks, paths, walks, and other portions of the Common Elements as may be from time to time intended and designated for such purpose and use; and for vehicular and pedestrian traffic over, through and across such portions of the Common Elements as may from time to time be paved and intended for such purposes, and such easements shall be for the use and benefit of the Owners within this Condominium and those claiming by, through or under the aforesaid; provided, however, nothing herein shall be construed to give or create in any person the right to park any vehicle upon any portion of the Condominium Property except to the extent that space may be specifically designated and assigned for parking purposes. Further, easements shall exist for ingress and egress over such streets, walks and other rights-of-way serving the Units as shall be necessary to provide for reasonable access to the public rights-of-way.

5.2 **Association Easements**. Except as limited by Section 718.111(10), Florida Statutes, the Association may grant easements from time to time over the Common Elements.

5.3 **Developer Easements**. The Developer hereby reserves the following exclusive easements and rights to grant easements:

- A. Marketing, Sales and Rental. The Developer reserves exclusive easement rights over and across the Condominium Property for the purpose of marketing, sales and rental of Units and other accommodations owned or operated by the Developer or one of its affiliates on adjoining properties which are not part of the Condominium.
- B. Governmental Requirements. The Developer hereby reserves the right to grant such easements from time to time as may be required by any government agency. Such easements shall specifically include, but not be limited to, any environmental easements required by state or federal environmental agencies for so long as the Developer holds any interest in any Unit subject to this Declaration.
- C. Developer Easements. The Developer reserves unto itself, for so long as it holds any interest in any Unit (including leaseholds), specific easement rights over and across the Condominium Property as it may deem necessary for its use from time to time.
- D. Construction Easements. The Developer, on behalf of itself and its affiliates, hereby reserves easement rights over, under and across the Condominium Property as is necessary from time to time for the purpose of constructing improvements on property adjacent to and in the vicinity of the Condominium Property, but only if access thereto is otherwise not reasonably available.

ARTICLE VI

UNITS

6.1 Description of Units. Each Unit shall include that part of a building containing the Unit that lies within the boundaries of the Unit, which boundaries are as follows:

- A. Upper and Lower Boundaries. The upper and lower boundaries of the Unit shall be the following boundaries extended to an intersection with the perimeter boundaries
- B. Upper Boundaries. The bottom surface of the lowest layer of the drywall ceiling attached to the bottom chord of the floor truss.
- C. Lower Boundaries. The plane of the lowest surface of the top of the unfinished floor slab.
- D. Perimeter Boundaries. The perimeter boundaries of the Unit shall be the following boundaries extended to an intersection with the upper and lower boundaries:
1. Exterior Building Walls. The intersecting vertical plane(s) of the innermost unfinished surfaces of the exterior wall of the building bounding such Unit and as to the entry which is a part of a Unit. Such boundaries shall be the intersecting vertical planes which include all of such structures of the innermost unfinished surface of the exterior concrete floor slab thereof.

2. **Interior Building Walls.** The vertical planes of the innermost unfinished surface of the interior walls attached to the party wall frame bounding such Unit extended to intersections with other perimetrical boundaries.

6.2 Warranty Limitation. EXCEPT FOR THOSE WARRANTIES REQUIRED BY CHAPTER 718, FLORIDA STATUTES, THE DEVELOPER DOES NOT MAKE ANY WARRANTY OF ANY KIND, EXPRESS OR IMPLIED, AND THE DEVELOPER HEREBY DISCLAIMS ANY SUCH WARRANTIES INCLUDING, BUT NOT LIMITED TO, IMPLIED WARRANTIES OF MERCHANTABILITY AND FITNESS FOR A PARTICULAR PURPOSE, AND THE OWNERS AND THE ASSOCIATION ASSUME ALL RISK AND LIABILITY RESULTING FROM THE USE OF THIS PROPERTY.

ARTICLE VII APPURTENANCES

7.1 Appurtenant Interests. As required under Florida Statutes, Section 718.104(4)(f), appurtenant to each Unit in the Condominium shall be an undivided ownership interest in the Common Elements, as well as an undivided share of the Common Expenses and Common Surplus. Each Unit will have appurtenant to it an undivided ownership interest in the Common Elements and a percentage share of the Common Expenses and Common Surplus as set forth in Article 3.2. The Owner of each Unit shall be liable for that share of the Common Expenses which equals the percentage interest in the Common Elements and Common Surplus appurtenant to its Unit.

7.2 Partition of Common Elements. The share of the undivided percentage interest in the Common Elements appurtenant to each Unit shall remain undivided, and no Owner shall bring, or have any right to bring, any action for partition or division of same.

ARTICLE VIII MAINTENANCE, ALTERATION AND IMPROVEMENT

Responsibility for the maintenance of the Condominium Property, and restrictions upon its alteration and improvement, shall be as follows:

8.1 Units, Common Elements and Limited Common Elements.

A. **By the Association.** Unless caused by the specific abuse of an Owner or any licensee, guest or tenant of an Owner, the Association shall maintain, repair and replace at the Association's expense:

1. All Common Elements and Limited Common Elements except as otherwise provided in the Condominium Documents.
2. All conduits, ducts, plumbing, wiring and other facilities for the furnishing of Utility Services.

B. By the Owner. The responsibility of the Owner for maintenance, repair and replacement shall be as follows:

1. To not paint or otherwise decorate or change the appearance of any portion of the Condominium Property without the prior written approval of the Association. Provided, however, that any unit owner may display one portable, removable United States flag in a respectful way and, on Armed Forces Day, Memorial Day, Flag Day, Independence Day, and Veterans Day, may display in a respectful way portable, removable official flags, not larger than 4 ½ feet by 6 feet, that represent the United States Army, Navy, Air Force, Marine Corps, or Coast Guard, regardless of any declaration rules or requirements dealing with flags or decorations.
2. To promptly report to the Association upon discovery any defect or need for repairs for which the Association is responsible.
3. To bear in their entirety any expenses of repairs or replacements to the Condominium Property occasioned by the specific use or abuse by any Owner or any licensee, guest or tenant of said Owner.
4. To maintain, repair and replace all components, furnishings, carpeting, appliances and other property, real, personal or mixed, located inside or comprising a Unit unless provided otherwise in the Condominium Documents.

8.2 Management Contract. The Association may enter into such management contracts from time to time as it deems necessary to engage the services of a management company to carry out all or part of the maintenance and operational duties and obligations of the Association in accordance with this Declaration. Any Management Contract must provide that at any time after turnover of control of the Association to Owners other than Developer, that the Association shall have the right, without penalty, to terminate the Management Contract upon not more than ninety (90) days advance written notice to the Management Company.

8.3 Association's Access to Units. The Association has the irrevocable right of access to each Unit and the Limited Common Elements appurtenant thereto whenever necessary for maintaining the Common Elements, for making emergency repairs necessary to prevent damage to the Common Elements or to another Unit and for servicing and reading utility lines, valves, conduits and meters.

ARTICLE IX

ASSESSMENTS AND COMMON EXPENSES

9.1 Common Expenses. In addition to those items defined as Common Expenses in Article 2.8 above, Common Expenses shall include the following:

- A. Repair, replacement and upkeep of the Common Elements.
- B. Casualty and/or liability insurance on the Condominium Property and fidelity

bonds;

C. Utility Services for the Condominium Property not attributable to individual Units;

D. Taxes on Association Property and any other applicable taxes other than Ad Valorem Real Estate Taxes assessed against individual Condominium Parcels; and

E. Any other expenses incurred in the normal operation and maintenance of the Condominium which cannot be attributed to a particular Owner.

9.2 Assessments. The mailing and collection of assessments against each Owner for Common Expenses, for the costs or expenses for which an individual Owner may be solely responsible pursuant to the terms of the Condominium Documents, and for reserves as may from time to time be established by the Association, shall be pursuant to the Bylaws of the Association, subject to the following provisions

A. Interest: Application of Payments. Assessments and installments on such assessments paid on or before five (5) days after the date when due shall not bear interest, but all sums not paid on or before five (5) days after the date when due shall bear interest at the maximum legal rate from the date when due until paid. A late charge equal to the greater of \$25.00 or 5% of the delinquent payment shall also be due on delinquent accounts. All payments on accounts shall be first applied to any interest that has accrued, then to any late charge, then to any costs and reasonable attorneys' and paralegals' fees incurred in collection, and then to the assessment payment first due. The board of directors shall have the discretion to increase or decrease the amount of late charge and/or interest rate within the limits imposed by law; provided, however, that such increase or decrease shall be made effective by amending the Condominium Rules and Regulations and notifying the Owners of same by regular mail addressed to each Owner at his last known address.

B. Lien for Assessments. The Association shall have a lien against each Condominium Parcel for any unpaid assessments which are due and which may accrue subsequent to the recording of the claim of lien and prior to the entry of a certificate of title, which lien shall also secure any interest, and all reasonable attorneys' fees and costs incurred by the Association incident to the collection process, whether or not legal proceedings are initiated. The lien is effective from and after recording a claim of lien, executed and acknowledged by an officer or authorized agent of the Association, in the Public Records of Alachua County, Florida, stating the legal description of the Condominium Parcel, the name of the Owner of record, the name and address of the Association, the amount claimed to be due and the due dates. The lien shall continue in effect until all sums secured by the lien shall have been fully paid or until such time as is otherwise permitted by law. Upon full payment, the party making payment shall be entitled to a recordable satisfaction of lien, to be prepared by and recorded at such party's expense. All such liens shall be subordinate to any mortgage recorded prior to the date of recording the claim of lien, and all such liens may be foreclosed by suit brought in the name of the Association in the same manner as a foreclosure of a mortgage on real property. The Association may also sue to recover a money judgment for unpaid

assessments without thereby waiving any claim of lien. Pursuant to Section 718.116(1), Florida Statutes, in the event a first Mortgagee shall obtain title to a Condominium Parcel as a result of the foreclosure of its mortgage, or in the event such first Mortgagee shall obtain title to a Condominium Parcel as the result of a conveyance in lieu of foreclosure of its mortgage, such first Mortgagee shall be liable for the unpaid Common Expenses and assessments that became due prior to the Mortgagee's acquisition of title. However, the first Mortgagee's liability is limited to the lesser of the Unit's unpaid Common Expenses and regular periodic assessments which accrued or came due during the six (6) months immediately preceding the acquisition of title and for which payment in full has not been received by the Association, or one percent (1%) of the original mortgage debt. Nothing contained herein shall be construed as a modification of any rights or remedies of the Association pursuant to Chapter 718, except to the extent that the Condominium Documents allow additional remedies to those expressly set forth in said statute and to the extent that such additional remedies are permitted by said statute.

C. Personal Liability for Unpaid Assessments. Each Owner of a Unit is personally liable for all assessments made against the Unit pursuant to this Declaration and Chapter 718, and the Association may bring an action for a money judgment against a delinquent Owner to collect all sums due the Association, including interest, late charges, costs and reasonable attorneys' and paralegals' fees. In the event a Unit is owned by more than one person or entity, such owners shall be jointly and severally liable for all assessments made against the Unit.

D. Payments of Assessments. No Owner may withhold payment of any regular assessment or special assessment or any portion thereof because of any dispute which may exist between that Owner and the Association, the directors of the Association, the Management Company or the Developer or among any of them but, rather, each Owner shall pay all assessments when due pending resolution of any dispute.

E. Notice of Delinquent Assessments. Any Mortgagee, upon written request to the Association (such request to state the name and address of such Mortgagee and the Unit number at issue), will be entitled to timely written notice of any delinquency in the payment of assessments or charges owned by an Owner of a Unit subject to the mortgage of such Mortgagee where such delinquency has continued for a period of sixty (60) days.

9.3 Common Surplus. Each Owner shall own a share of the Common Surplus attributable to each Unit owned in accordance with Article 3.2 above.

9.4 Refunds of Common Surplus. If the Association shall refund all or a portion of any Common Surplus to the Owners for any fiscal year in which the Developer paid any assessment, such refund shall be prorated as of the date of closing of any sale of a Unit upon which the sale was closed by the Developer during such year, and the prorated amount allocable to the period of time of the Developer's ownership shall be refunded directly to the Developer by the Association.

9.5 Certificate. Any Owner shall have the right to require from the Association a certificate showing the amount of unpaid assessments against him with respect to his Unit. The holder of a mortgage or other lien shall have the same right as to any Unit upon which it has a lien. Any person other than the Owner who relies upon such certificate shall be protected thereby.

ARTICLE X
THE ASSOCIATION

The operation of the Condominium shall be by the Association, which shall fulfill its functions pursuant to the following provisions:

10.1 Membership in Association. Membership of each Owner in the Association shall be acquired pursuant to the provisions of the Articles of Incorporation and Bylaws of the Association.

10.2 Number of votes for each Unit. Each Unit shall have one (1) vote.

10.3 Articles of Incorporation. A copy of the present Articles of Incorporation of the Association, which set forth its powers and duties, are attached hereto as **Exhibit "B"** and are incorporated herein by reference.

10.4 Bylaws. A copy of the present Bylaws of the Association are attached hereto as **Exhibit "C"** and are incorporated herein by reference.

10.5 Conflicts. In the event of conflict among the powers and duties of the Association or the terms and provisions of this Declaration or the exhibits attached hereto, this Declaration shall take precedence over the Articles of Incorporation, Bylaws and applicable rules and regulations; the Articles of Incorporation shall take precedence over the Bylaws and applicable rules and regulations; and the Bylaws shall take precedence over applicable rules and regulations, all as amended from time to time. Notwithstanding anything in this Declaration or its exhibits to the contrary, the Association shall at all times be the entity having ultimate authority over the Condominium, consistent with the Act.

10.6 Limitation Upon Liability of Association. Notwithstanding the duty of the Association to maintain and repair portions of the Condominium Property, the Association shall not be liable to Owners for injury or damage other than for the cost of maintenance and repair, caused by any latent condition of the property to be maintained and repaired by the Association or caused by the elements or other Owners or persons.

10.7 Restraint upon Assignment of Shares and Assets. Each Owner's share in the funds and assets of the Association cannot and shall not be assigned, hypothecated or transferred in any manner except as an appurtenance to his Unit.

10.8 Transfer of Control of Association. Owners other than the Developer shall be entitled to elect members of the board of directors pursuant to Article 5.11 of the Bylaws.

10.9 Management Contract. As set forth in Article 8.2 above, the Association is authorized to contract for management of the Condominium and to delegate to such contractor all powers and duties of the Association except such as are specifically required by the Condominium Documents to have approval of the board of directors or members of the Association.

10.10 Availability of Documentation. The Association shall be required to make available to Owners, any Mortgagee and the holders and insurers of the first mortgage on any Unit, current copies of this Declaration, the Articles and Bylaws of the Association and other rules governing this Condominium and other books, records and financial statements of the Association. The Association also shall make available to prospective purchasers current copies of this Declaration, the Association Articles and Bylaws, other rules governing the Condominium and the most recent annual audited financial statement, if such is prepared. "Available" shall at least mean available for inspection upon request, during normal business hours or under other reasonable circumstances.

ARTICLE XI **INSURANCE**

The insurance other than title insurance, if any, that shall be carried upon the Condominium Property shall be governed by the following provisions:

11.1 Authority to Purchase; Named Insured. All insurance policies upon the Condominium Property shall be purchased by the Association from a fiscally responsible company authorized to do business in the State of Florida and shall have a minimum term of one year. The named insured shall be the Association individually and as agent for the Owners, without naming them, and as agent for their Mortgagees. Such policies shall provide that payments by the insurer for losses shall be made to the Association or the Insurance Trustee designated below, and all policies and their endorsements shall be deposited with the Association or the Insurance Trustee. Such policies shall also include a "condominium endorsement" which shall provide for recognition on any insurance trust agreement, waiver of the right of subrogation against Owners individually, that the insurance is not prejudiced by any act or neglect of individual Owners which is not in the control of such Owners collectively and that the policy is primary in the event the Owners have other insurance covering the same loss. Such policies shall also include, to the extent available and commonly required by prudent institutional mortgage investors in the area, an "Agreed Amount Endorsement", "Inflation Guard Endorsement" and/or "Demolition or Building Code Endorsement".

11.2 Personal Property of Owners. If desired, each Owner shall obtain insurance coverage upon his personal property at his own expense, and such insurance shall not be the responsibility of the Association.

11.3 Coverage.

A. Casualty. All buildings and improvements upon the Condominium Property shall be insured in an amount equal to one hundred percent (100%) of the current replacement cost, exclusive of land, foundation and excavation costs, and all other items normally excluded from coverage, and all personal property owned by the Association shall be insured for its current replacement cost, all as shall be determined from time to time by the board of directors of the Association. Coverage shall afford protection against:

- (1) Loss or damage by fire and other hazards normally covered by a standard extended coverage endorsement;

(2) Such other risks as from time to time shall be customarily covered with respect to buildings similar in construction, location and use as the buildings on the Condominium Property, including floods and all other perils normally covered by the standard "all risk" endorsement where such is available, including, but not limited to, vandalism and malicious mischief.

B. Public Liability. Public liability insurance shall be carried in such amounts and with such coverage as shall be required by the board of directors of the Association from time to time; provided, however, that such coverage shall in no event be in an amount less than One Million Dollars (\$1,000,000.00) per occurrence. Wherever and whenever it is possible and economically feasible to do so, the board of directors shall attempt to obtain adequate insurance protection in reasonably prudent coverages. Except as required herein, nothing in this Declaration shall be construed to require the board of directors to obtain such coverage as a condition precedent to the Association conducting business.

C. Worker's Compensation. Worker's compensation insurance shall be carried to the extent necessary to meet the requirements of law.

D. Fidelity Bond. Fidelity insurance coverage shall be carried in the name of the Association for all officers, directors and employees of the Association and all other persons handling or responsible for funds of the Association. The total amount of fidelity bond coverage required shall be in the amount required for each such officer, director or employee as set forth in Section 718.111(11)(d), Florida Statutes, or in an amount not less than the estimated maximum of funds, including reserve funds, in the custody of the Association or Management Company, as the case may be, at any given time during the term of each bond, whichever is greater, but in no event may the aggregate amount of such bonds be less than a sum equal to three months' aggregate assessments on all Units plus reserve funds. The Association shall bear the cost of bonding. The fidelity bonds shall contain waivers by the issuers of the bonds of all defenses based upon the exclusion of persons serving without compensation from the definition of "employees", or similar terms or expressions. The fidelity bonds shall not be canceled or substantially modified (including cancellation for non-payment of premium) without at least ten (10) days' prior written notice to the Association. Such bonds must also provide that any FNMA servicer, on behalf of FNMA, must also receive such notice of cancellation or modification.

E. Other. Such other insurance may be carried as the board of directors of the Association shall determine from time to time to be desirable.

11.4 Premiums. Premiums upon insurance policies purchased by the Association shall be paid by the Association as a Common Expense.

11.5 Insurance Trustee; Share of Proceeds. All insurance policies purchased by the Association shall be for the benefit of the Association and the Owners and any Mortgagees as their interests may appear and shall provide that all proceeds covering property losses shall be paid to the Association or to a named Insurance Trustee (the "Insurance Trustee") if the board of directors shall so elect. All references to an Insurance Trustee herein shall apply to the Association if the board of directors elects not to appoint an Insurance Trustee. Any Insurance Trustee appointed by the board of directors

shall be a commercial bank with trust powers authorized to do business in Florida or another entity acceptable to the board of directors of the Association. The Insurance Trustee (other than the Association) shall not be liable for payment of premiums nor for the failure to collect any insurance proceeds. The duty of the Insurance Trustee shall be to receive such proceeds as are paid and hold the proceeds in trust for the purposes stated herein for the benefit of the Owners and any Mortgagees in the following shares; provided, however, that such shares need not be set forth on the records of the Insurance Trustee:

A. Proceeds on Account of Damage to Common Elements and Limited Common Elements. Proceeds on account of damage to Common Elements and Limited Common Elements shall be held in undivided shares for each Owner, such share being the same as the undivided share in the Common Elements and Limited Common Elements appurtenant to each Unit.

B. Units. Proceeds on account of damage to Units when the building or Unit is not to be restored shall be held in undivided shares for each Owner of those Units or Unit, such share being the same as the undivided share in the Common Elements appurtenant to each Owner's interest.

C. Mortgagees. Such insurance policies shall contain the standard mortgage clause or equivalent endorsement (without contribution) which is commonly accepted by private institutional mortgage investors in the area in which the condominium is located and which appropriately names FNMA and FHLMC, if such corporations are Mortgagees. In the event a Mortgagee endorsement has been issued, any share for the Owner shall be held in trust for the Mortgagee and the Owner as their interests may appear; provided, however, that no Mortgagee shall have the right to determine or participate in the determination as to whether any damaged property shall be reconstructed or repaired, and no Mortgagee shall have any right to apply or have applied to the reduction of a mortgage debt any insurance proceeds except distributions of such proceeds made to the Owner and Mortgagee pursuant to the provisions of this Declaration. Notwithstanding the foregoing, the Mortgagee shall have the right to apply or have applied to the reduction of its mortgage debt any or all sums of insurance proceeds applicable to its mortgaged interest in any of the following events:

1. When its mortgage is not in good standing and is in default; or
2. When insurance proceeds are insufficient to restore or repair the Unit to the condition existing prior to the loss and additional monies are not available for such purpose.

11.6 Distribution of Proceeds. Proceeds of insurance policies received by the Insurance Trustee shall be distributed to or for the benefit of the beneficial owners of such proceeds in the following manner:

A. All expenses of the Insurance Trustee shall be paid first or provisions made for such payment.

B. If the damage for which the proceeds are paid is to be repaired or reconstructed, the proceeds shall be paid to defray the cost thereof as provided herein. Any proceeds remaining after defraying such cost shall be distributed to the beneficial owners, remittances to Owners and any Mortgagees being payable jointly to them. This is a covenant for the benefit of, and may be enforced by, any Mortgagee.

C. If it is determined in the manner provided herein that the damage for which proceeds are paid shall not be reconstructed or repaired, the proceeds shall be distributed to the beneficial owners, remittances to Owners and any Mortgagees being payable jointly to them. This is a covenant for the benefit of, and may be enforced by, any Mortgagee.

D. In making distribution to Owners and any Mortgagees, the Insurance Trustee may rely upon a certificate of the Association made by its president and secretary as to the names of the Owners and their respective shares of the distribution.

11.7 Association as Agent and Attorney-in-Fact. The Association is hereby irrevocably appointed agent and attorney-in-fact for each Owner to adjust all claims arising under the insurance policies purchased by the Association and to execute and deliver releases upon the payment of a claim.

11.8 Notice to Owners and Mortgagees. No insurance policy required by this Declaration may be canceled or substantially modified without at least ten (10) days prior written notice to the Association and each Mortgagee holding a first mortgage and which is listed as a scheduled holder of a first mortgage in the policies. Certificates of insurance shall be issued to each Owner and Mortgagee upon written request therefor.

ARTICLE XII

RECONSTRUCTION OR REPAIR AFTER CASUALTY

12.1 Obligation to Reconstruct or Repair. If any part of the Condominium Property shall be damaged by casualty, whether or not it shall be reconstructed or repaired shall be determined in the following manner:

A. Common Elements and Limited Common Elements. If the damaged improvement is a Common Element or a Limited Common Element, then the damaged property shall be reconstructed or repaired unless it is determined that the Condominium shall be terminated because of damage to Units as set forth in Article 12.1(B) below.

B. Units.

1. Minor Damage. If the damage is to Units and if less than fifty percent (50%) of the Units are found by the board of directors of the Association to be untenable, the damaged property shall be reconstructed or repaired.

2. Major Damage. If the damage is to Units and if fifty percent (50%) or more of the Units are found by the board of directors of the Association to be untenable, then the damaged property will be reconstructed or repaired unless

within sixty (60) days after the casualty, the holders of ninety percent (90%) of all of the votes of the Association agree in writing to not reconstruct or repair and to terminate the Condominium. Any election to terminate the Condominium after substantial destruction or a substantial taking in condemnation of the Condominium Property must have the prior approval of the Mortgagees holding first mortgages on Units to which at least fifty-one percent (51%) of the votes of Units subject to mortgages held by Mortgagees are allocated.

C. Certificate. The Insurance Trustee may rely upon a certificate of the Association made by its president and attested by its secretary as to whether or not the damaged property is to be reconstructed or repaired.

12.2 Plans and Specifications. Any reconstruction or repairs must be substantially in accordance with the plans and specifications for the damaged property as originally constituted or, in lieu thereof, according to an amendment to the Declaration approved by the record owners of the units altered and all record owners of the liens on such units, and a majority of the record owners of all other units. Consent of any mortgagee may not be unreasonably withheld.

12.3 Estimates of Cost. Prior to rebuilding or repairing damage to property for which the Association has the responsibility of reconstruction and repair, the Association shall obtain reliable and detailed estimates of the cost to rebuild or repair.

12.4 Assessments. If the proceeds of insurance are not sufficient to defray the estimated costs of reconstruction and repair by the Association or if at any time during reconstruction and repair or upon completion of reconstruction and repair the funds from insurance for the payment of the costs of reconstruction and repair are insufficient, special assessments shall be made against all Owners in sufficient amounts to provide funds for the payment of such costs. Such special assessments shall be in proportion to the Owners' respective obligations for Common Expenses.

12.5 Construction Funds. The funds for payment of costs of reconstruction and repair after casualty, which shall consist of proceeds of insurance held by the Association or the Insurance Trustee and funds collected by the Association through assessments against Owners, shall be disbursed in payment of such costs in the following manner:

A. Association. If the total of assessments made by the Association in order to provide funds for the payment of costs of reconstruction and repair that are the responsibility of the Association is more than Fifty Thousand Dollars (\$50,000.00), then the sums paid upon such assessments shall be deposited by the Association with the Insurance Trustee (if other than the Association). In all other cases the Association shall hold the sums paid upon such assessments and disburse them in payment of the costs of reconstruction and repair.

B. Insurance Trustee. The proceeds of insurance collected on account of casualty and the sums deposited with the Insurance Trustee by the Association from collections of assessments against Owners on account of such casualty shall constitute a construction fund which shall be disbursed in payment of the costs of reconstruction and repair in the following manner and order:

1. Association - Minor Damage. If the amount of the estimated costs of reconstruction and repair that is the responsibility of the Association is less than Fifty Thousand Dollars (\$50,000.00), then the construction fund shall be disbursed in payment of such costs upon the order of the board of directors of the Association; provided however, that upon request by a Mortgagee that is a beneficiary of an insurance policy, the proceeds of which are included in the construction fund, such fund shall be disbursed in the manner provided for the reconstruction and repair of major damage.

2. Association - Major Damage. If the amount of the estimated costs of reconstruction and repair that are the responsibility of the Association is more than Fifty Thousand Dollars (\$50,000.00), then the construction fund shall be applied by the Insurance Trustee to the payment of such costs and shall be paid to or for the account of the Association from time to time as the work progresses but not more frequently than once in any calendar month. The Insurance Trustee shall make payments upon the written request of the Association for withdrawal of insurance proceeds, accompanied by a certificate dated not more than fifteen (15) days prior to such request, signed by an officer of the Association and by an architect in charge of the work, who shall be selected by the Association, setting forth that the sum then requested either has been paid by the Association or is justly due to contractors, subcontractors, materialmen, architects or other persons who have rendered services or furnished materials in connection with the work, giving a brief description of the services and materials and any amounts paid prior to the request, and stating that the sum requested does not exceed the value of the services and material described in the certificate; that, except for the amount stated in such certificate to be due as aforesaid, there is no outstanding indebtedness known to the person signing such certificate after due inquiry which might become the basis of a vendor's, mechanic's, materialmen's or similar lien upon such work against the Common Elements or any Unit; and that the cost as estimated by the person signing such certificate of the work remaining to be done subsequent to the date of such certificate does not exceed the amount of insurance proceeds or other funds remaining in the hands of the Insurance Trustee after the payment of the sum so requested.

3. Surplus. It shall be presumed that the first monies disbursed in payment of costs of reconstruction and repair shall be from insurance proceeds. If there is a balance in a construction fund after payment of all costs of the reconstruction and repair for which the fund is established, such balance shall be distributed to the beneficial owners of the fund; except, however, that only those portions of distribution to the beneficial owners in excess of assessments paid by an Owner to the construction fund shall be made payable to any Mortgagee.

4. Certificate. Notwithstanding the provisions of this instrument, the Insurance Trustee shall not be required to determine whether sums paid by the Owners upon assessments shall be deposited by the Association with the Insurance Trustee, nor to determine whether the disbursements from the construction fund are to be upon the order of the Association or approval of an architect or otherwise, nor whether a disbursement is to be made from the

construction fund, nor to determine the payee nor the amount to be paid. Instead, the Insurance Trustee may rely upon a Certificate of the Association made by its president and secretary as to any or all of such matters and stating that the sums to be paid are due and properly payable and stating the name of the payee and the amount to be paid; provided, that when a Mortgagee is required in this instrument to be named payee, the Insurance Trustee shall also name the Mortgagee as a payee of any distribution of insurance proceeds to an Owner; and further provided, that when the Association or a Mortgagee that is the beneficiary of an insurance policy whose proceeds are included in the construction fund so requires, the approval of an architect named by the Association shall be first obtained by the Association prior to disbursements in payment of costs of reconstruction and repair.

12.6 Eminent Domain. The Association is hereby empowered to defend and/or settle any action or threatened action with respect to the taking in condemnation of any portion of the Common Elements or any Unit or portion of any Unit. Upon obtaining knowledge of such action or threatened action, the Association shall notify all affected Mortgagees of record of same.

A. Common Elements. Any award or settlement made as a result of such a taking of all or a portion of the Common Elements shall be made payable to the Association. Any such award or settlement shall be held in trust by the Association for the benefit of the Owners and Mortgagees holding a first mortgage as their interests may appear. In the event any repair or restoration of the Common Elements is necessary in the opinion of a majority of the board of directors of the Association on account of such taking, or in the event a majority of the voting interests at a duly called and constituted meeting of the Association promptly approve such restoration or repair, the board of directors shall arrange for same and shall disburse such of the proceeds of such award or settlement as shall reasonably be necessary to effect such restoration or repair to the contractors engaged for such purpose in appropriate progress payments. The balance of such proceeds, or all of such proceeds if no determination to repair or restore is made, shall be disbursed by the Association in the same manner as insurance proceeds under Article 11.6 above where there is no repair or restoration of the damage.

B. Units. Any award or settlement for the taking in condemnation of a Unit shall be made payable to the Association for the benefit of the Owners thereof. In the event any repair or restoration of the Unit is necessary in the event a majority of the voting interests appurtenant to that Unit at a duly called and constituted meeting of the Association promptly approve such restoration or repair, the board of directors shall arrange for same and shall disburse such of the proceeds of such award or settlement as shall reasonably be necessary to effect such restoration or repair to the contractors engaged for such purpose in appropriate progress payments. The balance of such proceeds, or all of such proceeds if no determination to repair or restore is made, shall be disbursed by the Association as to the Owners of that Unit in the same manner as insurance proceeds under Article 11.6 above. If a temporary taking in condemnation of use (but not title) of a Unit occurs, the entire award or settlement for such temporary taking shall be paid to the Association for the benefit of the Owners of such Unit.

12.7 Notice to Mortgagees. Any Mortgagee, upon written request to the Association (such request to state the name and address of such Mortgagee and the Unit number at issue), will be entitled to timely written notice of any condemnation loss or any casualty loss which affects a material portion of the Condominium or which affects any Unit on which there is a first mortgage held, insured or guaranteed by such Mortgagee.

12.8 Consent Required for Reallocation of Interests in Common Elements. No reallocation of interests in the Common Elements resulting from a partial condemnation or partial destruction of the Condominium may be effected unless an amendment to the Declaration is approved by the record owners of the units altered and all record owners of the liens on such units, and a majority of the record owners of all other units. Consent of any mortgagee may not be unreasonably withheld.

ARTICLE XIII USE RESTRICTIONS

The use of the Condominium Property shall be in accordance with the following provisions as long as the Condominium exists:

13.1 Terms and conditions of Master Declaration. Use of all Units will be subject to the terms and conditions of the Master Declaration. Nothing in the Master Declaration shall conflict with the powers and duties of the Association or the rights of the Unit Owners as provided in Chapter 718, Florida Statutes.

13.2 Subdivision of Units. No Unit may be divided or subdivided into a smaller Unit.

13.3 Common Elements and Limited Common Elements. The Common Elements and Limited Common Elements shall be used only for the purposes for which they are intended in the furnishing of services and facilities for the enjoyment of the personal use of the Owners, their guests and lessees and other authorized occupants of Units.

13.4 Condominium Rules and Regulations. Reasonable rules and regulations concerning the use of Condominium Property may be promulgated and amended from time to time by the board of directors of the Association in the manner provided by its Articles of Incorporation and Bylaws.

13.5 Developer's Use. The Developer, its agents or an entity affiliated with the Developer may make such use of the Common Elements and the Units as may facilitate the sale or rental of Units, including, but not limited to, showing of the property and the display of signs and other promotional devices.

ARTICLE XIV ALIENABILITY OF UNITS

14.1 No Alienability Restrictions. The right of an Owner to sell, transfer, assign or hypothecate his Unit shall not be subject to the approval of the Association. Accordingly, a proper transfer or conveyance of such Unit shall not require the written approval of the Association.

14.2 Leasing and Rental Restrictions. Owners may lease or rent their Units in whole or in part and no approval by the Association shall be necessary therefor. All lessees shall be required to abide by the terms and conditions of this Declaration, as well as all Rules and Regulations adopted by the board of directors of the Association from time to time.

ARTICLE XV COMPLIANCE AND DEFAULT

15.1 Compliance and Default. Each Owner shall be governed by and shall comply with the terms of the Condominium Documents and the Condominium Rules and Regulations adopted pursuant to those documents and as they may be amended from time to time. Failure of an Owner to comply with the provisions of such documents and regulations shall entitle the Association or other Owners to pursue any and all legal and equitable remedies for the enforcement of such provisions, including, but not limited to, an action for damages, an action for injunctive relief or an action for declaratory judgment. Failure of the Association to comply with the provisions of the Condominium Documents and the Condominium Rules and Regulations adopted pursuant to those documents and as they may be amended from time to time shall entitle the Owners to pursue any and all legal and equitable remedies for the enforcement of such provisions, including, but not limited to, an action for damages, an action for injunctive relief or an action for declaratory judgment. All provisions of this Declaration shall be enforceable equitable servitudes and shall run with the land and shall be effective until the Condominium is terminated.

15.2 Costs and Attorneys' Fees. In any proceeding arising because of an alleged failure of an Owner or the Association to comply with the terms of the Condominium Documents or the Condominium Rules and Regulations adopted pursuant to them as they may be amended from time to time, the prevailing party shall be entitled to recover the costs of the proceeding and recover such reasonable attorneys' and paralegals' fees as may be awarded by the Court, including all appeals and all proceedings in bankruptcy.

15.3 No Waiver of Rights. The failure of the Association or any Owner to enforce any covenant, restriction or other provision of Chapter 718, the Condominium Documents or the Condominium Rules and Regulations shall not constitute a waiver of the right to do so thereafter.

15.4 Injunctive Relief. The Association may seek an injunction from a court of equity to compel or prohibit compliance or violation of the Condominium Documents regardless of whether an adequate remedy at law exists.

15.5 Governing Law; Waiver of Jury Trial; Venue of Actions. This Declaration shall be governed by, and shall be construed in accordance with, the laws of the State of Florida, as the same may exist on the date of recording hereof. The Association, an Owner or Owners, the Developer, the Management Company and any other party claiming rights or obligations by, through or under this Declaration, or two or more of the foregoing, each hereby waive any right they may have under any applicable law to a trial by jury with respect to any suit or legal action which may be commenced by or against the others concerning the interpretation, construction, validity, enforcement or performance of this Declaration or any other agreement or instrument executed in connection with this Declaration. In the event any such suit or legal action is commenced by any party, the other parties hereby agree, consent and submit to the personal jurisdiction of the circuit court for the county in which the Condominium is situated, with respect to such suit or legal action, and each party also hereby consents and submits to and

agrees that venue in any such suit or legal action is proper in said court and county, and each party hereby waives any and all personal rights under applicable law or in equity to object to the jurisdiction and venue in said court and county. Such jurisdiction and venue shall be exclusive of any other jurisdiction and venue.

ARTICLE XVI **AMENDMENTS**

16.1 Requirements. An amendment may be proposed either by the Board of Directors or by 25% of the voting interests of the Association, and may be considered at any meeting of the owners, regular or special, of which due notice has been given according to the Bylaws, which notice includes notice of the substance of the proposed amendment. Passage shall be evidenced by a certificate executed in recordable form signed by the President or Vice President of the Association that the amendment has been enacted by the affirmative vote of the required percentage of voting interests. The certificate shall include the original recording reference for the Declaration and shall become effective when recorded in the public records. Except as otherwise provided herein, such amendment must be approved by not less than sixty-seven percent (67%) of the votes of the Association.

16.2 Amendments Altering Units or Appurtenances. No amendment may change the configuration or size of any Unit in any material fashion, materially alter or modify the appurtenances to the Unit, or change the proportion or percentage by which the Unit Owner shares the common expenses of the condominium and owns the common surplus of the condominium unless the record owner of the unit and all record owners of liens on the unit join in the execution of the amendment and unless all the record owners of all other units approve the amendment. Consent of any mortgagee may not be unreasonably withheld.

16.3 Correctory Amendment. Whenever it shall appear that there is a defect, error, or omission in any of the Condominium documents or in order to comply with applicable laws or requirements of government entities, the amendment may be adopted by the Board of Directors alone.

16.4 Developer Amendments. Until relinquishment of Developer control of the Association and except as otherwise provided by law in Florida Statutes Section 718.110(2), the Developer specifically reserves the right, without joinder of any person, to make such amendments to the Declaration and its exhibits, or to the plan of development, as may be required by any lender or governmental authority, or as may be in Developer's judgment, necessary or desirable. This paragraph shall take precedence over any other provision of the Declaration or its exhibits except as prohibited by law.

16.5 Mortgagee Approval. Amendments materially affecting the rights or interests of mortgagees must have the approval of the holders of institutional first mortgages of record representing 51% of the votes of units subject to such mortgages who have requested the Association to notify them on any such proposed action. Consent of a mortgagee under this provision may not be unreasonably withheld. Implied approval shall be assumed when such mortgage holder fails to respond to any written request for approval within 30 days after the mortgage holder receives proper notice of the proposal, provided the notice was delivered certified or registered mail with a "Return Receipt" requested. In the event that mortgagee consent is provided other than by properly recorded joinder, such consent shall be evidence by affidavit of the Association and recorded in the Public Records of Alachua County, Florida.

16.6 Developer's Rights. No amendment to this Declaration or any of the condominium documents shall change the rights and privileges of the Developer without the Developer's written approval as long as the Developer holds any units for sale in the ordinary course of business.

16.7 Written Agreements. Any approval of units owners on any matter called for by this Declaration, its exhibits, or any statute to be taken at a meeting of unit owners is hereby expressly allowed to be taken instead by written agreement, without a meeting (which agreement may be in counterparts), subject to F. S. 718.112(2)(D)(4) AND F.S. 617.0701.

ARTICLE XVII **TERMINATION**

The Condominium may be terminated in the following manners, in addition to the manner provided by Chapter 718:

17.1 Agreement. The Condominium may be terminated at any time by the approval in writing of all Owners and all Mortgagees of record. Notice of a meeting at which the proposed termination is to be considered shall be given not less than thirty (30) days prior to the date of such meeting.

17.2 Termination Through Condemnation. The Condominium shall only be terminated by virtue of a condemnation action if all Condominium Property is taken in condemnation. If less than all of the Condominium Property is taken in condemnation, the Condominium shall continue as to those portions of the Condominium Property not so taken.

17.3 Certificate. Termination of the Condominium in either of the foregoing manners shall be evidenced by a certificate of the Association executed by its president and secretary certifying to the facts effecting the termination, said certificate to become effective upon being recorded in the Public Records of Alachua County, Florida.

17.4 Shares of Owners after Termination. After termination of the Condominium, each Owner shall own an undivided share of the Condominium Property and all assets of the Association as a tenant in common in accordance with this Declaration.

17.5 Notice to Mortgagees. Any Mortgagee, upon written request to the Association (such request to state the name and address of such Mortgagee and the Unit number at issue), will be entitled to timely written notice of any proposed termination of the Condominium.

ARTICLE XVIII **MERGER**

This Declaration, the Association and the Common Elements of the Condominium described herein may be merged with the declaration of condominium, condominium association and common elements of another independent and separate condominium to form a single condominium upon prior notification to the Division and with the consent of sixty-six and two-thirds percent (66 2/3%) of the total number of voting interests and with the approval of all of the record owners of liens on the Units. In

the event such consent and approval is obtained, a new or amended declaration of condominium, articles of incorporation and bylaws of the Association shall be recorded and shall contain such provisions as are necessary to amend and modify the appurtenances to the Units and percentages by which the Owners of Units share the Common Expenses and own the Common Surplus and Common Elements in order to create a consolidated single condominium.

ARTICLE XIX
SEVERABILITY

The invalidity in whole or in part of any covenant or restriction, or any article, section, subsection, sentence, clause, phrase or word, or other provision of the Condominium Documents and the Condominium Rules and Regulations shall not affect the validity of the remaining portions.

ARTICLE XX
MASTER ASSOCIATION VOTING RIGHTS AND COMMON EXPENSES

Pursuant to Articles III and VI of the Master Declaration, the votes and percentage of common expenses attributable to each Unit for the Metro 39 Office Park Master Association, Inc. are based on the relative square footages of each Unit compared to the total number of square feet in all 5 buildings. The initial votes and percentage share of common expenses are set forth below:

<u>Unit</u>	<u>Number of Votes</u>	<u>Share of Common Expenses</u>
A	1944	8.9%
B	1282	2.6%
C	1282	2.6%
D	1944	3.9%

The number of votes and percentage share allocated above are based on a total build-out of 50,000 square feet for all 5 buildings. At such time as the total square footage has been finally determined by the Declarant, Declarant shall have the right and authority to amend this Article XX to establish the final number of votes and the percentage share of common expenses to be allocated per Unit.

IN WITNESS WHEREOF, the Developer has executed this Declaration this 8 day of May, 2007.

Witnesses:

HOWE DEVELOPMENT CORPORATION,
a Florida corporation

Angela D. Lee

Angela D. Lee
Printed Name

[Signature]

Gwendolyn D. Jones
Printed Name

By: [Signature]
Richard R. Howe, President

STATE OF FLORIDA
COUNTY OF ALACHUA

The foregoing instrument was acknowledged before me this 8 day of May, 2007 by Richard R. Howe as President of Howe Development Corporation, a Florida Corporation. Such person(s):

- is/are personally known to me.
- produced a current Florida Driver's license as identification.
- produced _____ as identification.

(SEAL)

Angela D. Lee
Print Name: Angela D. Lee
Notary Public, State of Florida
My Commission Expires:
Serial Number:

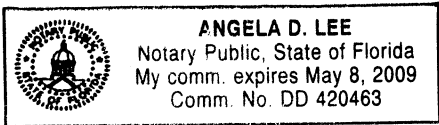

**CONSENT OF MORTGAGEE
TO DECLARATION OF CONDOMINIUM**

THIS CONSENT made and entered into this 8 day of May, 2007, by CAPITAL CITY BANK ("Mortgagee").

WITNESSETH:

WHEREAS, Mortgagee is the owner and holder of the following:

A. Mortgage executed by Howe Development Corporation, a Florida Corporation, and Richard R. Howe and Leigh Anne Howe, husband and wife, in favor of CAPITAL CITY BANK in the amount of \$2,550,000.00, dated January 26, 2006, and recorded January 27, 2006, in Official Records Book 3304, Page 1442 of the Public Records of Alachua County, Florida (the "Mortgage"); and

WHEREAS, the Mortgage encumbers the land and the improvements located thereon (the "Property"), described in the Declaration of Condominium of BUILDING 3, METRO 39 OFFICE PARK CONDOMINIUM, hereinafter referred to as the "Declaration", to which this Consent is attached; and

WHEREAS, Mortgagee has agreed to consent to the Declaration.

NOW, THEREFORE, Mortgagee agrees as follows:

1. Mortgagee does hereby consent to the recordation of the Declaration, provided, however, no amendment to the Declaration shall be effective against Mortgagee unless Mortgagee has executed a joinder and consent as to said amendment.
2. Mortgagee agrees that the lien of the Mortgage, as the same applies to and encumbers the Property, shall be upon the Condominium Parcels of BUILDING 3, METRO 39 OFFICE PARK CONDOMINIUM.
3. This Consent shall apply and be effective solely to the Property, and nothing herein contained shall otherwise affect, alter or modify in any manner whatsoever the terms and conditions, lien, operation, effect and priority of the Mortgage as to the Condominium Parcels in BUILDING 3, METRO 39 OFFICE PARK CONDOMINIUM and any other land or improvements encumbered by the Mortgage.

IN WITNESS WHEREOF, Mortgagee has caused this instrument to be executed by its duly authorized officer the day and year first above written.

"MORTGAGEE"

Witnesses:

CAPITAL CITY BANK



Print Name Carri-Anne Powell

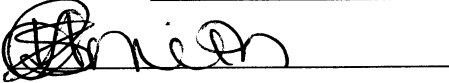

Print Name H. Power Smith

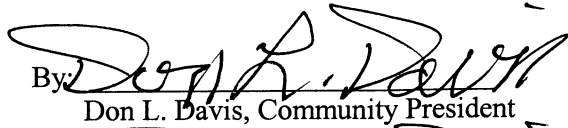
By: 
Don L. Davis, Community President

Print Name Don L. Davis

STATE OF FLORIDA
COUNTY OF ALACHUA

BEFORE ME, the undersigned authority authorized to take acknowledgments in the state and county aforesaid, appeared DON L. DAVIS known to me to be the COMMUNITY PRESIDENT of CAPITAL CITY BANK, who acknowledged that he executed the foregoing instrument on behalf of the bank pursuant to due authority therefrom. He is personally known to me or has produced _____ as identification and did (did not) take an oath.

WITNESS my hand and seal this 8th day of May, 2007.

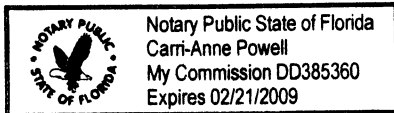

(NOTARY SEAL)



Printed Name _____
Commission No. _____

EXHIBIT 'A-1'

A PART OF LOT 4 OF "METROCORP CENTER OF GAINESVILLE" AS RECORDED IN PLAT BOOK "M", PAGE 43 OF THE PUBLIC RECORDS OF ALACHUA COUNTY, FLORIDA, DESCRIBED BY:

FOR A POINT OF REFERENCE COMMENCE AT A RAILROAD SPIKE MARKING THE NORTHWEST CORNER OF SECTION 26, TOWNSHIP 9 SOUTH, RANGE 19 EAST; THENCE SOUTH 00°08'31" WEST, ALONG THE WEST LINE OF SAID SECTION, A DISTANCE OF 49.71 FEET; THENCE SOUTH 89°51'29" EAST, A DISTANCE OF 50.00 FEET; THENCE NORTH 89°48'32" EAST ALONG THE NORTHERLY LINE OF THE SAID LOT 4 AND THE EXTENSION THEREOF, A DISTANCE OF 204.39 FEET TO THE WESTERLY LINE OF LANDS DESCRIBED IN OFFICIAL RECORDS BOOK 3304, PAGE 1440 OF THE PUBLIC RECORDS OF ALACHUA COUNTY, FLORIDA; THENCE DEPARTING SAID NORTHERLY LINE SOUTH 00°11'28" EAST, ALONG THE SAID WESTERLY LINE, A DISTANCE OF 32.21 FEET; THENCE DEPARTING SAID WESTERLY LINE NORTH 89°48'30" EAST, A DISTANCE OF 170.90 FEET TO THE NORTHWEST CORNER OF AN EXISTING BUILDING, AND THE POINT OF BEGINNING; THENCE CONTINUE NORTH 89°48'30" EAST, ALONG THE NORTHERLY EXTERIOR WALL FACE OF SAID EXISTING BUILDING, A DISTANCE OF 14.50 FEET; THENCE DEPARTING SAID NORTHERLY EXTERIOR WALL FACE NORTH 00°11'30" WEST, A DISTANCE OF 2.32 FEET; THENCE NORTH 89°52'00" EAST, A DISTANCE OF 34.30 FEET; THENCE SOUTH 00°11'30" EAST, A DISTANCE OF 2.29 FEET TO SAID NORTHERLY EXTERIOR WALL FACE; THENCE NORTH 89°48'30" EAST, ALONG SAID NORTHERLY EXTERIOR WALL FACE, A DISTANCE OF 28.21 FEET; THENCE DEPARTING SAID NORTHERLY EXTERIOR WALL FACE NORTH 00°11'30" WEST, A DISTANCE OF 2.31 FEET; THENCE NORTH 89°50'41" EAST, A DISTANCE OF 38.77 FEET; THENCE SOUTH 00°11'30" EAST, A DISTANCE OF 2.29 FEET TO SAID NORTHERLY EXTERIOR WALL FACE; THENCE NORTH 89°48'30" EAST, ALONG SAID NORTHERLY EXTERIOR WALL FACE, A DISTANCE OF 12.99 FEET TO THE EASTERLY EXTERIOR WALL FACE OF SAID EXISTING BUILDING; THENCE SOUTH 00°11'04" EAST, ALONG SAID EASTERLY EXTERIOR WALL FACE, A DISTANCE OF 49.73 FEET TO THE SOUTHERLY EXTERIOR WALL FACE OF SAID EXISTING BUILDING; THENCE SOUTH 89°47'42" WEST, ALONG SAID SOUTHERLY EXTERIOR WALL FACE, A DISTANCE OF 12.97 FEET; THENCE DEPARTING SAID SOUTHERLY EXTERIOR WALL FACE SOUTH 00°12'18" EAST, A DISTANCE OF 3.31 FEET; THENCE SOUTH 89°48'45" WEST, A DISTANCE OF 38.76 FEET; THENCE NORTH 00°12'18" WEST, A DISTANCE OF 3.30 FEET TO THE SAID SOUTHERLY EXTERIOR WALL FACE; THENCE SOUTH 89°47'42" WEST, ALONG SAID SOUTHERLY EXTERIOR WALL FACE, A DISTANCE OF 28.28 FEET; THENCE DEPARTING SAID SOUTHERLY EXTERIOR WALL FACE SOUTH 00°12'18" EAST, A DISTANCE OF 3.29 FEET; THENCE SOUTH 89°48'42" WEST, A DISTANCE OF 34.37 FEET; THENCE NORTH 00°12'18" WEST, A DISTANCE OF 3.28 FEET TO THE SAID SOUTHERLY EXTERIOR WALL FACE; THENCE SOUTH 89°47'42" WEST, ALONG SAID SOUTHERLY EXTERIOR WALL FACE, A DISTANCE OF 14.37 FEET TO THE WESTERLY EXTERIOR WALL FACE OF SAID EXISTING BUILDING; THENCE NORTH 00°12'54" WEST ALONG THE SAID WESTERLY EXTERIOR WALL FACE, A DISTANCE OF 49.76 FEET TO THE POINT OF BEGINNING.

THE ABOVE DESCRIBED LANDS CONTAINS 6,814 SQUARE FEET, MORE OR LESS

INSTRUMENT # 236778
55 PGS

BUILDING 3, METRO 39
OFFICE PARK CONDOMINIUM
 PART OF LOT 4, METROCORP CENTER OF GAINESVILLE, AS RECORDED IN PLAT BOOK "M", PAGE 43 OF THE PUBLIC RECORDS OF ALACHUA COUNTY, CITY OF GAINESVILLE, ALACHUA COUNTY, FLORIDA

CONDOMINIUM
 BOOK _____ PAGE _____
 SHEET 1 OF 6

SHEET LAYOUT:
 SHEET 1 = TOTAL SITE
 SHEET 2 = BUILDING PLAN
 SHEETS 3-6 = UNIT PLANS

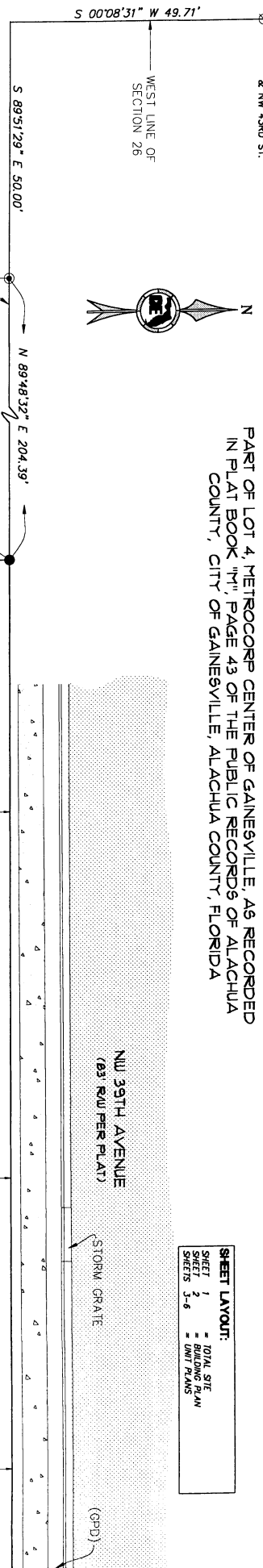

LEGAL DESCRIPTION: (BY THIS SURVEY)
 A PART OF LOT 4 OF "METROCORP CENTER OF GAINESVILLE" AS RECORDED IN PLAT BOOK "M", PAGE 43 OF THE PUBLIC RECORDS OF ALACHUA COUNTY, FLORIDA, COMMENCING AT A METROCORP SHIP MARKING THE NORTHEAST CORNER OF SECTION 26, TOWNSHIP 9 NORTH, RANGE 18 EAST, DISTRICT OF 48-171 FEET, THENCE SOUTH 89°51'29\"/>

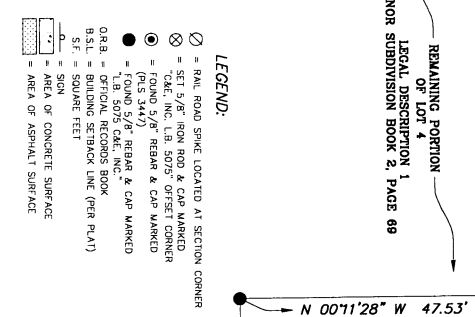

NOTES:
 1. ALL AREAS NOT SPECIFICALLY DESIGNATED AS UNIT AREA OR LIMITED COMMON ELEMENT AREA ARE COMMON ELEMENT AREAS.
 2. ALL AREAS NOT SPECIFICALLY DESIGNATED AS UNIT AREA OR LIMITED COMMON ELEMENT AREA ARE COMMON ELEMENT AREAS.
 3. ALL AREAS NOT SPECIFICALLY DESIGNATED AS UNIT AREA OR LIMITED COMMON ELEMENT AREA ARE COMMON ELEMENT AREAS.
 4. BUILDING AS SHOWN HEREON IS GROUND FLOOR FOOTPRINT.

CLERK OF THE COURT:
 HEREBY RECEIVED AND FILED THIS PLAN FOR RECORD
 THIS _____ DAY OF _____ YEAR OF 2007

 CLERK OF THE CIRCUIT COURT

CONSTRUCTION NOTE:
 SUBMITTALS SHALL COMPLY WITH THE LATEST EDITIONS OF THE FLORIDA BUILDING CODE AND ALL APPLICABLE LOCAL ORDINANCES.
 ALL CONSTRUCTION SHALL BE IN ACCORDANCE WITH THE LATEST EDITIONS OF THE FLORIDA BUILDING CODE AND ALL APPLICABLE LOCAL ORDINANCES.
 ALL CONSTRUCTION SHALL BE IN ACCORDANCE WITH THE LATEST EDITIONS OF THE FLORIDA BUILDING CODE AND ALL APPLICABLE LOCAL ORDINANCES.

SURVEYOR'S NOTES:
 1. THIS SURVEY WAS PERFORMED BY ME OR UNDER MY CLOSE PERSONAL SUPERVISION AND I AM A LICENSED SURVEYOR IN THE STATE OF FLORIDA.
 2. THE SURVEYOR HAS NO KNOWLEDGE OF UNRECORDED FOUNDATIONS WHICH WOULD AFFECT THE SURVEY EXCEPT AS SHOWN.
 3. THE SURVEYOR HAS NO KNOWLEDGE OF UNRECORDED FOUNDATIONS WHICH WOULD AFFECT THE SURVEY EXCEPT AS SHOWN.
 4. THE SURVEYOR HAS NO KNOWLEDGE OF UNRECORDED FOUNDATIONS WHICH WOULD AFFECT THE SURVEY EXCEPT AS SHOWN.
 5. THE SURVEYOR HAS NO KNOWLEDGE OF UNRECORDED FOUNDATIONS WHICH WOULD AFFECT THE SURVEY EXCEPT AS SHOWN.

LINE	LENGTH	BEARING
L1	39.21'	S00°11'28\"/>

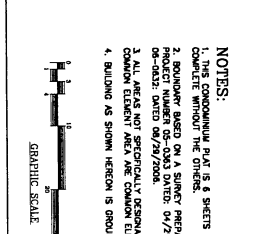

SURVEYOR'S CERTIFICATION:
 I, ALAN L. TILLY, A PROFESSIONAL SURVEYOR IN THE STATE OF FLORIDA, DO HEREBY CERTIFY THAT, TO THE BEST OF MY KNOWLEDGE AND BELIEF, THE PART CONDOMINIUM AS SHOWN HEREON, ARE SUBSTANTIALLY CORRECT AS SHOWN, AND THIS DECLARATION DESCRIBING THE CONDOMINIUM INTERESTS IS AN OATH AND NOT A STATEMENT OF OPINION.
 I HEREBY CERTIFY AND THAT THE IDENTIFICATION OF REAL PROPERTY ELEMENTS, UNITS, COMMON AREAS, AND EACH UNIT HAS BEEN DETERMINED.

INSTRUMENT # 2336778
55 PGS

PART OF LOT 4, METROCORP CENTER OF GAINESVILLE, AS RECORDED
IN PLAT BOOK "M", PAGE 43 OF THE PUBLIC RECORDS OF ALACHUA
COUNTY, CITY OF GAINESVILLE, ALACHUA COUNTY, FLORIDA

**BUILDING 3, METRO 39
OFFICE PARK CONDOMINIUM**

CE Causeaux & Ellington, Inc. 518
Engineering • Surveying • Planning
6011 NW 1st Place, Gainesville, Florida 32607
Phone: (352) 331-5745
FAX: (352) 331-5746
www.causeaux.com

CONDOMINIUM
BOOK _____, PAGE _____
SHEET 3 OF 6

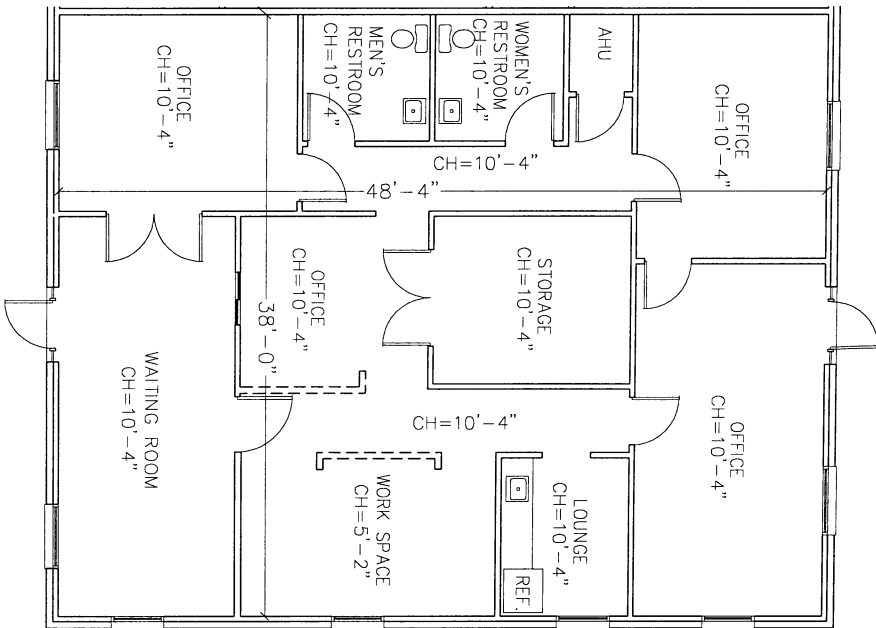

UNIT FLOOR PLAN

THIS SHEET DEPICTS: UNIT A

- LEGEND**
- CH = CEILING HEIGHT
 - REF. = REFRIGERATOR
 - AHU = AIR HANDLING UNIT
 - = PARTIAL HEIGHT PARTITION WALL

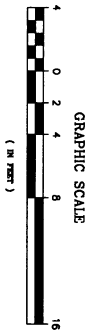

NOTES

BUILDING PLANS AS SHOWN HEREON ARE BASED ON
PLANS PROVIDED BY THE CLIENT.
THIS CONDOMINIUM GRAPHIC DESCRIPTION IS A
SUMMARY OF THE INFORMATION SHOWN ON THE ORIGINAL SHEET IS NOT COMPLETE

NOTE:
CONSTRUCTION IS
SUBSTANTIALLY COMPLETE.

UNIT "A"
FLOOR PLAN
SHEET 3

INSTRUMENT # 2336778
55 PGS

BUILDING 3, METRO 39
OFFICE PARK CONDOMINIUM
PART OF LOT 4 METROCORP CENTER OF GAINESVILLE, AS RECORDED
IN PLAT BOOK "M", PAGE 43 OF THE PUBLIC RECORDS OF ALACHUA
COUNTY, CITY OF GAINESVILLE, ALACHUA COUNTY, FLORIDA

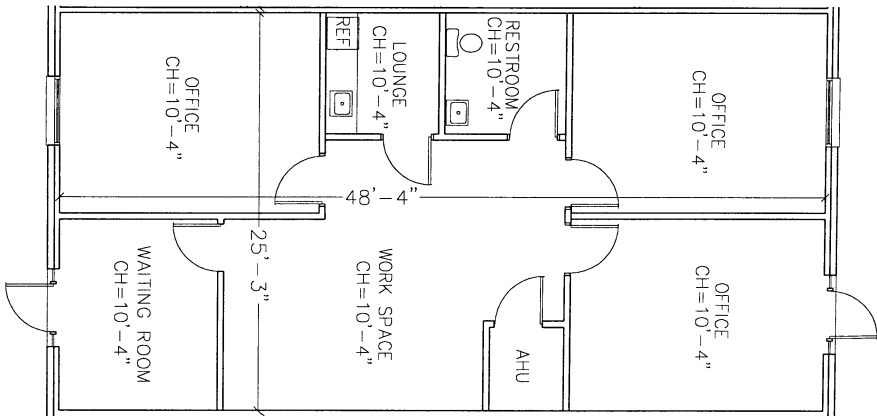

UNIT FLOOR PLAN

THIS SHEET DEPICTS: UNIT B

GRAPHIC SCALE

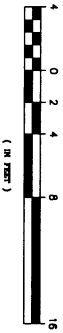

LEGEND
CH = CEILING HEIGHT
REF. = REFRIGERATOR
AHU = AIR HANDLING UNIT

NOTES

BUILDING PLANS AS SHOWN HEREON ARE BASED ON
PLANS PROVIDED BY THE CLIENT.
THIS CONDOMINIUM GRAPHIC DESCRIPTION IS &
WITHOUT THE OTHERS.

NOTE:
CONSTRUCTION IS
SUBSTANTIALLY COMPLETE.

Causeaux & Ellington, Inc.
Engineering • Surveying • Planning
4011 NW 1st Place, Gainesville, Florida 32607
Phone: (352) 335-8700
United Business No. 807

CONDOMINIUM
BOOK _____, PAGE _____
SHEET 4 OF 6

UNIT "B"
FLOOR PLAN
SHEET 4

INSTRUMENT # 2336778
55 PGS

BUILDING 3, METRO 39
OFFICE PARK CONDOMINIUM
PART OF LOT 4, METROCORP CENTER OF GAINESVILLE, AS RECORDED
IN PLAT BOOK "M", PAGE 43 OF THE PUBLIC RECORDS OF ALACHUA
COUNTY, CITY OF GAINESVILLE, ALACHUA COUNTY, FLORIDA

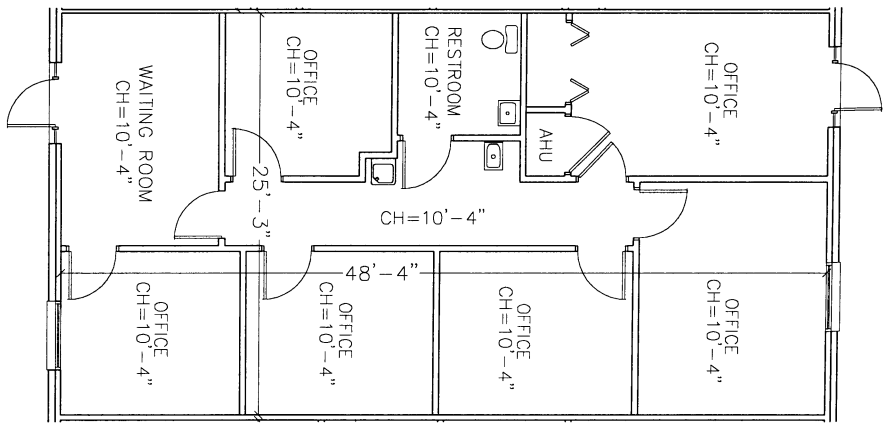

UNIT FLOOR PLAN

THIS SHEET DEPICTS: UNIT C

LEGEND
CH = CEILING HEIGHT
REF. = REFRIGERATOR
AHU = AIR HANDLING UNIT

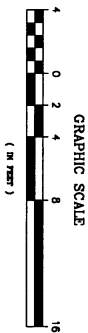

NOTES
BUILDING PLANS AS SHOWN HEREON ARE BASED ON
PLANS PROVIDED BY THE CLIENT.
THIS CONDOMINIUM GRAPHIC DESCRIPTION IS &
WITHOUT THE OTHERS.

NOTE:
CONSTRUCTION IS
SUBSTANTIALLY COMPLETE.

CE Causeaux & Ellington, Inc.
Engineering • Surveying • Planning
1000 N. W. 10th Street, Suite 200
Gainesville, FL 32609
Phone: (352) 331-1000
FAX: (352) 331-1001
LICENSED BUSINESS NO. 5075

CONDOMINIUM
BOOK _____, PAGE _____
SHEET 5 OF 6

UNIT "C"
FLOOR PLAN
SHEET 5

INSTRUMENT # 2336778
55 PGS

BUILDING 3, METRO 39
OFFICE PARK CONDOMINIUM
PART OF LOT 4 METROCORP CENTER OF GAINESVILLE, AS RECORDED
IN PLAT BOOK "M", PAGE 43 OF THE PUBLIC RECORDS OF ALACHUA
COUNTY, CITY OF GAINESVILLE, ALACHUA COUNTY, FLORIDA

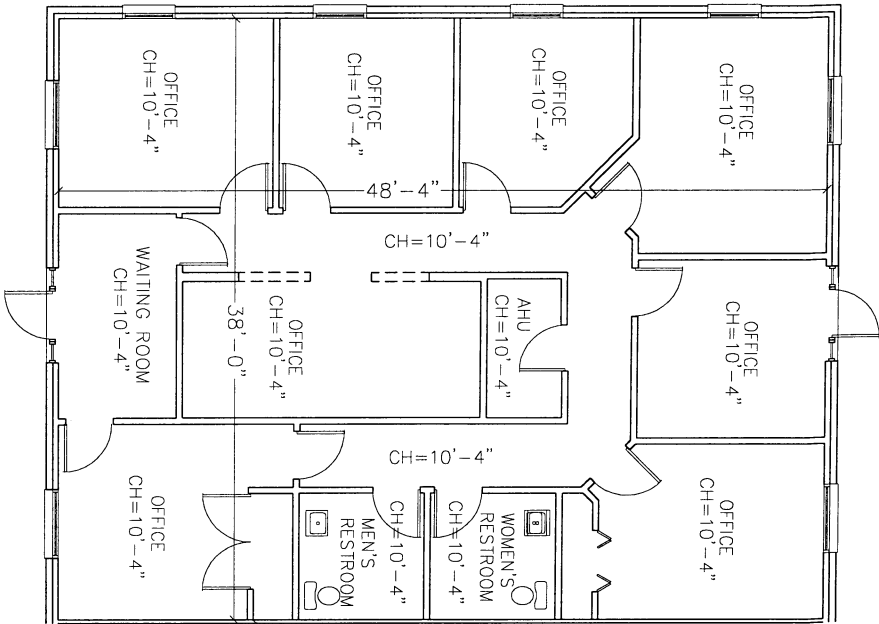

UNIT FLOOR PLAN

THIS SHEET DEPICTS: UNIT D

- LEGEND**
- CH = CEILING HEIGHT
 - REF. = REFRIGERATOR
 - AHU = AIR HANDLING UNIT
 - = PARTIAL HEIGHT PARTITION WALL

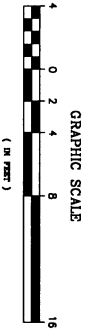

NOTES

BUILDING PLANS AS SHOWN HEREON ARE BASED ON
PLANS PROVIDED BY THE CLIENT.
THIS CONDOMINIUM GRAPHIC DESCRIPTION IS A
SUMMARY OF THE OFFICE
WHICH THE OFFICE

NOTE:
CONSTRUCTION IS
SUBSTANTIALLY COMPLETE

CE Causeaux & Ellington, Inc.
Engineering • Surveying • Planning
3011 NW 1st Place, Gainesville, Florida 32607
Phone: (352) 333-5700
License Number No. 2073

CONDOMINIUM
BOOK _____, PAGE _____
SHEET 6 OF 6

UNIT "D"
FLOOR PLAN
SHEET 6

State of Florida



Department of State

I certify the attached is a true and correct copy of the Articles of Incorporation of BUILDING 3, METRO 39 OFFICE PARK CONDOMINIUM ASSOCIATION, INC., a Florida corporation, filed on April 24, 2007, as shown by the records of this office.

The document number of this corporation is N07000004152.

Given under my hand and the
Great Seal of the State of Florida
at Tallahassee, the Capitol, this the
Twenty-fifth day of April, 2007

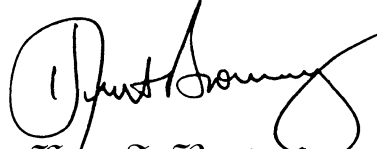

CR2EO22 (01-07)

Kurt S. Browning
Secretary of State

**ARTICLES OF INCORPORATION
OF
BUILDING 3, METRO 39 OFFICE PARK CONDOMINIUM ASSOCIATION, INC.,
a Florida not for profit corporation**

THE UNDERSIGNED hereby associate themselves together for the purpose of forming a corporation not for profit under Chapter 617, Florida Statutes, and certify as follows:

**ARTICLE I
Name**

The name of the corporation shall be BUILDING 3, METRO 39 OFFICE PARK CONDOMINIUM ASSOCIATION, INC. For convenience this corporation shall be referred to as the "Association".

**ARTICLE II
Definitions and Purposes**

1. Unless otherwise defined herein, all capitalized terms shall have the meaning given such terms in the Declaration (as defined below).
2. The purposes for which the Association is organized is to manage, operate and maintain the condominium to be known as BUILDING 3, METRO 39 OFFICE PARK CONDOMINIUM, a condominium, hereinafter referred to as the "Condominium", in accordance with the Declaration of Condominium of Building 3, Metro 39 Office Park Condominium, a condominium (hereinafter the "Declaration"). All terms used in these Articles of Incorporation shall have the same meaning as the identical terms utilized in the Declaration, unless the context otherwise requires.
3. The Association shall have no capital stock and shall make no distribution of income or profit to its members, directors or officers.

**ARTICLE III
Powers**

1. The Association shall have all of the common law and statutory powers of a corporation not for profit which are not in conflict with the terms of these Articles.
2. The Association shall have all of the powers reasonably necessary to implement the purpose of the Association, including but not limited to the following:
 - a. To adopt a budget and make and collect assessments against members to defray the costs of the Condominium.
 - b. To use the proceeds of assessments in the exercise of its powers and duties.
 - c. To maintain, manage, repair, replace and operate the Condominium Property.

2007 APR 24 PM 12:13
SECRETARY OF STATE
TALLAHASSEE, FLORIDA

150

- d. To reconstruct improvements after casualty and construct further improvements to the Condominium Property.
- e. To promulgate and amend the Condominium Rules and Regulations respecting the use of Condominium Property.
- f. To enforce by legal means the provisions of the various Condominium Documents, these Articles, the Bylaws of the Association and the Condominium Rules and Regulations.
- g. Pursuant to the terms of the Declaration, to contract for the management of the Condominium and to delegate to such contractor all powers and duties of the Association except such as are specifically required by the various Condominium Documents and applicable law to have approval of the board of directors or the members of the Association. Notwithstanding any provisions contained in these Articles to the contrary, it is the intent of these Articles that the ability of the board of directors of the Association to independently terminate a contract for the management of the Condominium without a vote of the Owners as provided in Chapter 718 shall be governed solely by the terms and conditions of said management contract.
- h. To serve as the association for condominiums other than the Condominium in the discretion of the board of directors, in which case the terms "Unit" and "Owners" as used in these Articles and the Bylaws shall refer to Units and Owners in any condominium operated by this Association.

3. All funds and the titles to all property acquired by the Association and the proceeds thereof shall be held only for the benefit of the members in accordance with the provisions of the Condominium Documents.

4. The powers of the Association shall be subject to and shall be exercised in accordance with the provisions of the Declaration.

ARTICLE IV
Members

The qualifications of members, the manner of their admission, and voting by members shall be as set forth in the Bylaws of the Association.

ARTICLE V
Directors

1. The affairs of the Association will be managed by a board of directors of not less than three (3) nor more than seven (7) directors as shall be determined by the Bylaws, and in the absence of such determination shall consist of three (3) directors.

2. Directors of the Association shall be appointed or elected at the annual meeting of the members in the manner determined by the Bylaws.

3. The following persons shall serve as directors until their successors are elected or appointed as provided in the Bylaws:

<u>Name</u>	<u>Address</u>
Richard R. Howe	3940 N. W. 16 th Boulevard, Bldg A. Gainesville, FL 32605
Leigh Anne Howe	3940 N. W. 16 th Boulevard, Bldg A. Gainesville, FL 32605
James D. Salter	3940 N. W. 16 th Boulevard, Bldg B. Gainesville, FL 32605

ARTICLE VI
Officers

The affairs of the Association shall be administered by a president, a vice-president, a secretary, a treasurer, and as many assistant vice-presidents, assistant secretaries and assistant treasurers as the board of directors shall from time to time determine. Such officers shall be elected by the board of directors at its first meeting following each annual meeting of the members of the Association. Officers shall serve without compensation at the pleasure of the board of directors. Any person may hold two or more offices, the duties of which are not incompatible; provided, however, that the president shall not also be the vice-president, secretary or treasurer, or assistant secretary or assistant treasurer. The names and addresses of the officers who shall serve until their successors are designated by the board of directors are as follows:

President:	Richard R. Howe 3940 N. W. 16 th Boulevard, Bldg A. Gainesville, FL 32605
Vice President:	Leigh Anne Howe 3940 N. W. 16 th Boulevard, Bldg A. Gainesville, FL 32605
Secretary/Treasurer:	James D. Salter 3940 N. W. 16 th Boulevard, Bldg B. Gainesville, FL 32605

ARTICLE VII
Indemnification

Every director and every officer of the Association shall be indemnified by the Association against all expenses and liabilities, including attorneys' and paralegals' fees, reasonably incurred by or

imposed upon him in connection with any proceeding to which he may be a party, or in which he may become involved by reason of his being or having been a director or officer at the time such expenses are incurred, except in such cases wherein the director or officer is adjudged guilty of willful misfeasance or malfeasance in the performance of his duties; provided that in the event of a settlement, the indemnification herein shall apply only when the board of directors has approved such settlement and when the board of directors has approved such settlement and reimbursement as being in the best interests of the Association. The foregoing indemnification shall be in addition to and not exclusive of all other rights to which such director or officer may be entitled.

ARTICLE VIII
Bylaws

The Bylaws shall be adopted by the board of directors and may be altered, amended or rescinded by not less than two-thirds (2/3) of all the directors until the first election of a majority of directors by Owners other than the Developer. Thereafter, the Bylaws may be altered, amended or rescinded as provided Therein.

ARTICLE IX
Amendments

Amendments to these Articles of Incorporation shall be proposed and adopted in the following manner:

1. Notice of the subject matter of a proposed amendment shall be included in the notice of any meeting at which a proposed amendment is considered.
2. Until the first election of a majority of directors by members other than the Developer, proposal of an amendment and approval thereof shall require the affirmative action of two-thirds (2/3) of the entire membership of the board of directors, and no meeting of the members nor any approval thereof need be had.
3. After the first election of a majority of directors by members other than the Developer, a resolution approving a proposed amendment may be proposed by either the board of directors or by the members of the Association, and after being proposed and approved by one of such bodies, requires the approval of the other body. Except as otherwise provided herein, such approvals must be by not less than two-thirds (2/3) of all the directors and by not less than a majority vote of the members of the Association at a duly called meeting of the Association.
4. An amendment when adopted shall be effective when filed with the Secretary of State of the State of Florida and recorded in the Public Records of the county in which the Condominium is situated.
5. At any time prior to the first election of a majority of directors by members other than the Developer, these Articles of Incorporation may be amended by the Developer without the approval of the board of directors or the membership of the Association as may be required by any governmental entity or institutional lender or as may be necessary to conform these Articles to any governmental statutes.

INSTRUMENT # 2336778
55 PGS

ACCEPTANCE OF APPOINTMENT AS REGISTERED AGENT

The undersigned hereby accepts the appointment to serve as the initial Registered Agent of BUILDING 3, METRO 39 OFFICE PARK CONDOMINIUM ASSOCIATION, INC.

MELISSA JAY MURPHY

FILED
2007 APR 24 PM 12:13
SECRETARY OF STATE
TALLAHASSEE, FLORIDA

EXHIBIT "C"

**BYLAWS
OF
BUILDING 3, METRO 39 OFFICE PARK CONDOMINIUM ASSOCIATION, INC.,
a Florida not-for-profit corporation**

**ARTICLE I
IDENTITY**

These are the Bylaws of Building 3, Metro 39 Office Park Condominium Association, Inc., a corporation not-for-profit under the laws of the State of Florida, hereinafter referred to as the "Association" and under the Articles of Incorporation (the "Articles") which have been filed in the office of the Secretary of State. The Association has been organized for the purpose of administering a condominium upon certain lands in Alachua County, Florida known as Building 3, Metro 39 Office Park Condominium, a Condominium (the "Condominium"), in accordance with the Declaration of Condominium for Building 3, Metro 39 Office Park Condominium, a Condominium (the "Declaration").

1.1 Office. The office of the Association shall be at 3940 NW 16th Blvd., Building A, Gainesville, FL 32605, or at such other place as may be designated by the board of directors from time to time.

1.2 Fiscal Year. The fiscal year of the Association shall be the calendar year.

1.3 Seal. The seal of the corporation shall bear the name of the corporation, the word "Florida," the words "Corporation Not-for-Profit," and the year of incorporation.

**ARTICLE II
DEFINITIONS**

The terms used in these Bylaws shall have the same meaning as the identical terms utilized in the Declaration, unless the context otherwise requires.

**ARTICLE III
MEMBERS**

3.1 Qualification. The members of the Association shall consist of every Owner, including the Developer, and in the case of multiple Owners, every group of record Owners of a Unit in the Property. The foregoing is not intended to include persons or entities who hold an interest merely as security for performance of an obligation. Membership shall be appurtenant to and may not be separated from ownership of the Unit.

3.2 Change of Membership. Change of membership in the Association shall be established by recording in the Public Records of Alachua County, Florida, a deed or other instrument establishing record title to a Unit under the jurisdiction of the Association. The Owner designated as grantee by such instrument thus becomes a Member of the Association and the membership of the prior Owner is terminated. The new Owner shall notify the Association of such property transfer and furnish the Association a copy of the recorded deed, the new Owner's address, and the Owner's local agent, if any, in the event the Owner is located outside the State of Florida. Any notice requirements set out in these

bylaws and in the Articles shall be deemed to be complied with if notice to an Owner is directed to the address of said owner as then reflected in the Association's records.

3.3 Designation of Voting Representative. If a Unit is owned by one person or entity, its rights to vote shall be established by the record title to the Unit. If a Unit is owned by more than one person or entity, the person entitled to cast the votes for the Unit shall be designated by a certificate signed by all of the record Owners of the Unit and filed with the secretary of the Association. If a Unit is owned by a general or limited partnership, the person entitled to cast the votes for the Unit shall be designated by a certificate of appointment signed by one of the general partners and filed with the secretary of the Association. If a Unit is owned by a corporation, the person entitled to cast the votes for the Unit shall be designated by a certificate of appointment signed by the president or vice president of the corporation and filed with the secretary of the Association. If a Unit is owned in trust, the person entitled to vote for the Unit shall be designated by a certificate of appointment signed by the trustee of record for the trust and filed with the secretary of the Association. Such certificates shall be valid until revoked or until superseded by a subsequent certificate or until a change in the ownership of the Unit concerned. A certificate designating the person entitled to cast the votes of a Unit may be revoked in writing by any Owner thereof, provided, however, that no Unit shall vote in excess of the voting rights allocated to that Unit pursuant to the Declaration.

3.4 Approval or Disapproval of Matters. Approval or disapproval of a member upon any matter, whether or not the subject of an Association meeting, shall be by the same person, corporation or other entity who would cast the vote of such member if in an Association meeting.

ARTICLE IV **MEMBERS' MEETINGS**

4.1 Annual Members' Meeting. The annual members' meeting shall be held within 30 days from the end of the fiscal year at such time, place and date as may be designated by the board of directors, for the purpose of electing directors and of transacting any other business authorized to be transacted by the members.

4.2 Special Members' Meetings. Special members' meetings shall be held whenever called by the president or vice-president or by majority of the board of directors and must be called by such officers upon receipt of a written request from twenty percent (20%) of the voting interests except as provided for in Article V below. Unless otherwise set forth in the notice of special meeting, as provided for above, all special meetings shall be held in Alachua County, Florida.

4.3 Notice of Members' Meetings. Notice of all members' meetings stating the time and place and the agenda for which the meeting is called shall be mailed, delivered or electronically transmitted by the president or secretary, unless waived in writing. Such notice shall be sent in writing to each member at his address as it appears on the books of the Association and shall be sent to each member not less than fourteen (14) days nor more than sixty (60) days prior to the date of the meeting. The post office certificate of mailing shall be retained in the records of the Association as proof of such mailing. In addition, a notice of the meeting shall be posted at a conspicuous place on the Condominium Property or Association Property, which location shall be duly adopted by rule by the board, upon notice to the Unit Owners, at least for fourteen (14) continuous days prior to said meeting; however, if there is no Condominium Property or Association Property upon which notices can be posted, this requirement does not apply. Members may waive notice of specific meetings and may take action by written agreement without meetings. As provided in the Declaration, Mortgagees, as that term is defined in the Declaration, shall, upon prior written request, be entitled to receive notice of all members' meetings.

Failure to provide such notice shall not invalidate any action taken at an otherwise properly noticed meeting. Where assessments against members are to be considered for any reason at a members' meeting, the notice shall contain a statement that assessments will be considered and shall specify the nature of any such assessment.

4.4 Quorum. The presence in person or by proxy of members representing a majority of the total voting interests eligible to vote shall constitute a quorum, and decisions shall be made by the vote of a majority of the members at a meeting at which a quorum is present.

If any meeting of members cannot be organized because a quorum has not been achieved, the members who are present, either in person or by proxy, may adjourn the meeting from time to time until a quorum is present.

4.5 Number of Votes for Each Unit. The total number of votes attributable to the Units is set forth in the Declaration.

4.6 Proxies. Votes may be cast in person or by proxy in accordance with and as permitted by applicable law. Any proxy given shall be effective only for the specific meeting for which originally given and any lawfully adjourned meetings thereof and must be filed with the secretary at or before the appointed time of the meeting. Each proxy shall specifically set forth the name of the person voting by proxy, the name of the person authorized to vote the proxy for him, and the date the proxy was given. Each proxy shall contain the date, time and place of the meeting for which the proxy is given, and if a limited proxy, set forth those items which the holder of the proxy may vote and the manner in which the vote is cast. In no event shall any proxy be valid for a period of longer than ninety (90) days after the date of the first meeting for which it was given. Every proxy shall be revocable at any time at the pleasure of the member executing it. If a proxy expressly provides, any proxy holder may appoint, in writing, a substitute to act in his place. If such provision is not made, substitution is not authorized.

4.7 Order of Business. The order of business at annual members' meetings and, as far as practicable at all other members' meetings, shall be:

- A. Ballots not yet cast shall be collected and validated.
- B. Call to order.
- C. Election of chairman of the meeting.
- D. Calling of the roll and certifying of proxies.
- E. Proof of notice of meeting or waiver of notice.
- F. Reading and disposal of any unapproved minutes.
- G. Report of officers.
- H. Report of committees.
- I. Election of directors.
- J. Unfinished business.

- K. New business.
- L. Adjournment.

4.8 Developer's Rights. For so long as the Developer holds Units for sale in the ordinary course of business, none of the following actions may be taken without approval in writing by the Developer:

- A. Assessment of the Developer as the Owner of Units for capital improvements; and,
- B. Any action by the Association that would be detrimental to the sale of Units by the Developer.

ARTICLE V

BOARD OF DIRECTORS

5.1 Number. The affairs of the Association shall be managed by a board of directors who shall be members of the Association, except that the first board of directors and their successors appointed by the remaining directors (in the event of vacancies occurring before the first election of a majority of directors by members) need not be members. The initial board of directors shall consist of three (3) directors, and thereafter the membership of the board shall consist of not less than three (3) nor more than seven (7) directors. Within these limits, the board of directors may from time to time increase or decrease the number of persons to serve on the board, except that the board shall always contain an odd number of members. Where units are owned by corporations, the officers, directors, employees or other appointed representatives of said corporations shall be eligible to serve on the board of directors of the Association on behalf of the corporation.

5.2 Qualifications. All directors shall be members of the Association, provided, however, that all directors that the Developer is entitled to elect or designate need not be members.

5.3 Directors' Fees. Directors' fees, if any, shall be determined by the members of the Association, and no director shall receive a fee prior to the election of a majority of the members of the board of directors by Owners other than the Developer.

5.4 Nominations. Any Unit Owner or other eligible person may nominate himself or may nominate another unit owner or eligible person. Any Unit Owner or other eligible person desiring to be a candidate for the board of directors must give written notice to the Association not less than 40 days before a scheduled election.

5.5 Election of Directors. Members of the board of directors shall be elected by written ballot or voting machine on the date of the annual meeting. Proxies shall in no event be used in elections to fill vacancies caused by recall, resignation, or otherwise, unless specifically allowed by Chapter 718, Florida Statutes. Not less than 60 days before a scheduled election, the Association shall mail or deliver, whether by separate association mailing or included in another association mailing or delivery including regularly published newsletters, to each unit owner entitled to vote, a first notice of the date of the election. Prior to the election, the Association shall, pursuant to Florida Statutes, mail or deliver a second notice of the election to all Unit Owners entitled to vote therein, together with a ballot which shall list all candidates. Upon request of a candidate, the Association shall include an information sheet, pursuant to

section 5.6 below, which must be furnished by the candidate not less than 35 days before the election, to be included with the mailing of the ballot. Elections shall be decided by a plurality of those ballots cast. There shall be no quorum requirement; however, at least 20% of the eligible voters must cast a ballot in order to have a valid election of members of the board of directors.

5.6 Candidate Information Sheet. Each candidate may provide to the Association an information sheet, no larger than 8 1/2 inches by 11 inches, which must be furnished by the candidate not less than 35 days before the election, to be included with the mailing of the ballot, with costs of mailing and copying to be borne by the Association. The Association shall have no liability for the contents of the information sheets prepared by the candidates.

5.7 Organizational Meeting. The organizational meeting of a newly elected board of directors shall be held within ten (10) days of their election at such place and time as shall be fixed by the directors at the meeting at which they were elected or at a time and place so announced at said meeting. Notice of the organizational meeting shall be given in the same manner as set forth in Article VI, section 6.1 below.

5.8 Term of Office. Members of the board of directors who are elected by Owners other than the Developer at the annual meeting of members shall serve for one (1) year until the next annual meeting of the members and thereafter, unless and until his successor is duly elected or qualified or until he is removed in the manner elsewhere provided. The directors named in the Articles of Incorporation shall serve until the first election of directors.

5.9 Removal. Owner directors may be removed from the board of directors pursuant to Section 718.112(2) (j), Florida Statutes. Anything to the contrary contained herein notwithstanding, any director who is appointed by the Developer may be removed by the Developer at any time. Upon such removal, the Developer shall immediately appoint a replacement director and notify the remaining directors, if any, of such removal and appointment.

5.10 Vacancy. Vacancies on the board of directors may be filled by majority of the remaining directors, even though a quorum may not exist. A director appointed to fill a vacancy in office shall serve the remainder of the term of the office to which he is appointed. Any vacancies in office occurring before the first election shall be filled by the remaining directors. In the event there are no remaining directors, then any such vacancies shall be filled by the Developer.

5.11 Transfer of Association Control. Owners of Units other than the Developer will be entitled to elect members of the board of directors as follows:

A. At such time as fifteen percent (15%) or more of the Units that will be operated ultimately by the Association are owned by Owners other than the Developer, the Owners of Units other than the Developer shall be entitled to elect not less than one third (1/3) of the members of the board of directors of the Association.

B. Owners of Units other than the Developer shall be entitled to elect not less than a majority of the members of the board of directors of the Association upon the earliest of:

1. three (3) years after fifty percent (50%) of the Units that will be operated ultimately by the Association have been conveyed to purchasers; or

2. three (3) months after ninety percent (90%) of the Units that will be operated ultimately by the Association have been conveyed to purchasers; or
3. when all the Units that will be operated ultimately by the Association have been completed, some of them have been conveyed to purchasers, and none of the others are being offered for sale by the Developer in the ordinary course of business; or
4. when some of the Units have been conveyed to purchasers and none of the others are being constructed or offered for sale by the Developer in the ordinary course of business.

C. The Developer shall be entitled to elect not less than one (1) member of the board of directors of the Association as long as the Developer holds for sale in the ordinary course of business at least five percent (5%) of the Units that will be operated ultimately by the Association.

D. As to the election of directors pursuant to Subparagraphs A, B, and C above, within seventy-five (75) days after Owners other than the Developer are entitled to elect a member or members of the board of directors of the Association, the Association shall call and give not less than sixty (60) days notice of an election for the members of the board. The election shall proceed pursuant to Article V, Section 5.5, above.

E. Following the time the Developer relinquishes control of the Association, the Developer may exercise the right to vote any Developer-owned Units in the same manner as any other Owner except for purposes of requiring control of the Association or selecting the majority members of the board of directors.

F. Nothing in this subparagraph shall be construed so as to preclude the Developer from relinquishing control of the board of directors at any time the Developer may so elect.

ARTICLE VI

MEETINGS OF DIRECTORS

6.1 Regular Meetings. Regular meetings of the board of directors may be held at such time and place as shall be determined from time to time by a majority of the directors. Notice of regular meetings shall be given to each director, personally or by mail, telephone or electronic transmission at least three (3) days prior to the date named for such meeting unless such notice is waived.

Notice of all meetings of the board, including adjourned meetings, shall specifically incorporate an identification of agenda items and be posted in a conspicuous place on the Condominium Property for the benefit of members at least forty-eight (48) continuous hours in advance of such meeting, except in an emergency. Any item not included on the notice may be taken up on an emergency basis by at least a majority plus one of the members of the board. Such emergency action shall be noticed and ratified at the next regular meeting of the board. However, written notice of any meeting at which nonemergency special assessments, or at which amendment to rules regarding unit use, will be considered shall be mailed, delivered, or electronically transmitted to the unit owners and posted conspicuously on the condominium property not less than 14 days prior to the meeting. Evidence of compliance with this 14-day notice shall be made by an affidavit executed by the person providing the notice and filed among the official records of the association.

Upon notice to the Unit Owners, the board shall duly adopt a rule designating a specific location on the Condominium Property or Association Property upon which all notices of board meetings shall be posted. If there is no Condominium Property or Association Property upon which notices can be posted, notices of board meetings shall be mailed, delivered or electronically transmitted at least 14 days before the meeting to the Owner of each Unit.

All meetings of the board of directors shall be open to all Unit Owners, who shall have the right to speak with reference to all designated agenda items subject to reasonable rules governing the frequency, duration, and manner of Unit Owner statements.

6.2 Special Meetings. Special meetings of the directors may be called by the president and must be called by the secretary at the written request of one-third (1/3) of the votes of the board. Not less than three (3) days notice of the meeting shall be given personally or by mail, telephone or electronic transmission, which notice shall state the time, place and purpose of the meeting.

6.3 Waiver of Notice. Any director may waive notice of a meeting before or after the meeting, and such waiver shall be deemed equivalent to the giving of notice. Any director's attendance at a meeting shall constitute a waiver of the notice of that meeting.

6.4 Quorum. A quorum at directors' meetings shall consist of the directors entitled to cast a majority of the votes of the entire board. The acts of the board approved by a majority of votes present shall constitute the acts of the board of directors except as specifically otherwise provided in the Declaration. If at any meeting of the board of directors there is less than a quorum present, the majority of those present may adjourn the meeting from time to time until a quorum is present.

6.5 Presiding Officer. The presiding officer at board of directors' meetings shall be the president of the Association. In the absence of the president the vice-president shall preside.

ARTICLE VII

POWERS AND DUTIES OF THE BOARD OF DIRECTORS

All of the powers and duties of the Association shall be exercised by the board of directors including those existing under the common law, statutes, the Articles and the Condominium Documents. Such powers and duties of the directors shall be exercised in accordance with the provisions of the Declaration which governs the use of the land, and shall include but not be limited to the following:

1. To adopt a budget and to make and collect assessments against Owners to defray the costs of operating the Condominium.
2. To use the proceeds of assessments in the exercise of its powers and duties.
3. To lease, maintain, manage, repair, replace and operate the Condominium property, including but not limited to, obtaining and maintaining adequate insurance to protect the Association and the Condominium property.
4. To reconstruct improvements after casualty and to construct further improvements to the Condominium property.

5. To promulgate and amend the Condominium Rules and Regulations respecting the use of Condominium Property. Such rules and regulations may be promulgated by the board of directors at any duly noticed meeting of the board or of the members.

6. To enforce by legal means the provisions of the Condominium Documents, the Articles, these Bylaws, and the Condominium Rules and Regulations.

7. To contract for management of the Condominium and to delegate to such contractor all powers and duties of the Association except such as are specifically required by the Condominium Documents or applicable law to have approval of the board of directors or members of the Association. Notwithstanding any provisions contained in these Bylaws to the contrary, it is the intent of these Bylaws that the ability of the board of directors of the Association to independently terminate a contract for the management of the Condominium without a vote of the Owners as provided in Chapter 718 shall be governed solely by the terms and conditions of said management contract.

8. To pay the cost of all power, water, sewer and other utility services rendered to the Condominium and not billed to Owners of individual Units.

9. To employ personnel for reasonable compensation to perform the services required for proper administration of the purposes of the Association, including but not limited to accountants and attorneys.

10. To bond any or all employees, officers and directors of the Association, for which the Association shall bear the costs.

11. To maintain all books and records concerning the Condominium including, but not limited to, the maintenance of a complete list of the names and addresses of all Owners of Units, a copy of which shall be provided to the Division of Florida Land Sales, Condominiums and Mobile Homes upon request.

ARTICLE VIII **OFFICERS**

8.1 Officers and Election. The executive officers of the corporation shall be a president, a vice-president, a secretary, and a treasurer, all of whom shall be directors who shall be elected annually by the board of directors at any meeting. Any person may hold two or more offices except that the president shall not also be the vice-president, secretary or treasurer, or assistant secretary or assistant treasurer. The board of directors shall from time to time elect such other officers and designate their powers and duties as the board determines necessary to manage the affairs of the Association.

8.2 President. The president shall be the chief executive of the Association. He shall have all of the powers and duties which are usually vested in the office of president including, but not limited to, the power of appointing committees from among the members from time to time, as he may in his discretion determine appropriate, to assist in the conduct of the affairs of the Association.

8.3 Vice President. The vice-president shall in the absence of or disability of the president exercise the powers and duties of the president. He shall also generally assist the president and exercise such other powers and perform such other duties as shall be prescribed by the directors.

8.4 Secretary. The secretary shall keep the minutes of the proceedings of the directors and the members in a book available for inspection by the directors or members, or their authorized representatives, at any reasonable time. The Association shall retain these minutes for a period of not less than seven (7) years. He shall attend to the giving and serving of all notices required by law. He shall have custody of the seal of the Association and affix the same to instruments requiring a seal when duly signed. He shall perform all other duties incident to the office of secretary of an Association and as may be required by the directors or the president.

8.5 Treasurer. The treasurer shall have custody of all property of the Association, including financial records, funds, securities and evidences of the indebtedness. He shall keep the financial records of the Association and shall keep the assessment rolls, the accounts of the members, and the books of the Association in accordance with generally accepted accounting practices. He shall perform all other duties incident to the office of treasurer.

8.6 Compensation. The compensation of all employees of the Association shall be fixed by the directors. This provision shall not preclude the board of directors from employing a director or officer as an employee of the Association nor preclude the contracting with a director for the management of the Condominium.

ARTICLE IX **FISCAL MANAGEMENT**

The provisions for fiscal management of the Association set forth in the Declaration and the Articles shall be supplemented by the following provisions:

9.1 Assessments.

A. Regular Assessments. The board of directors of the Association shall fix and determine from time to time the sum or sums necessary and adequate for the Common Expenses of the Condominium. In the absence of a determination by the directors as to the frequency of assessments, assessments shall be due and payable monthly. Common Expenses shall include the expenses for the operation, maintenance, repair or replacement of the Common Elements and the Limited Common Elements, costs of carrying out the powers and duties of the Association, all insurance premiums and expenses relating thereto, including fire insurance and extended overage, and any other expenses designated as Common Expenses from time to time by the board of directors of the Association, or under the provisions of the Declaration. Funds for the payment of Common Expenses shall be assessed against the members in the proportions of percentages of sharing Common Expenses, as provided in the Declaration. Assessments shall be made against members in an amount not less than required to provide funds in advance for payment of all of the anticipated current operating expenses and for all of the unpaid operating expenses previously incurred. The personal liability of a member for assessments shall survive the termination of such member's membership in the Association.

B. Special Assessments. Special assessments, should such be required by the board of directors, shall be levied in the same manner as provided for regular assessments, and shall be payable in the manner determined by the board of directors.

C. Delinquency and Default. Assessments for Units shall become due as determined by the board of directors from time to time, and shall be considered delinquent if payment has not been received on or before the fifteenth day after the due date, unless otherwise ordered by the board of directors.

If a member shall be in default in the payment of any assessment due on his Unit, the Association shall have all collection rights available to it under Chapters 718, Florida Statutes and the Declaration. If any unpaid share of Common Expenses or assessments is extinguished by foreclosure of a superior lien or by a deed in lieu of foreclosure thereof, the unpaid share of Common Expenses or assessments shall be Common Expenses collectible from all the Owners.

D. Assessment Roll. The assessment roll shall be maintained in a set of accounting books in which there shall be an account for each Unit. Such an account shall designate the name and address of the members or member, the dates and amounts in which the assessments come due, the amounts paid upon the account and the balance due upon assessments.

E. Certificate. Any member shall have the right to require from the Association a certificate showing the amount of unpaid assessments against him with respect to his Unit. The holder of a mortgage or other lien shall have the same right as to any Unit upon which he has a lien. Any person other than the Owner who relies upon such certificate shall be protected thereby.

F. Notice for Considering Assessments. Notice of any meeting, whether a meeting of the board of directors or of the members of the Association, at which assessments against members are to be considered for any reason shall specifically contain a statement that assessments will be considered and the nature of such assessments.

9.2 Budget.

A. Annual Budget. The board of directors shall adopt a budget for each calendar year which shall contain estimates of the cost of performing the functions of the Association and estimates of the income of the Association. The proposed annual budget of Common Expenses shall be detailed and shall show the amounts budgeted by accounts and expense classifications. In addition to annual operating expenses, the budget shall include reserve accounts for capital expenditures and deferred maintenance. These accounts shall include, but not be limited to, roof replacement and building painting. The amount to be reserved shall be computed by means of a formula which is based upon estimated life and estimated replacement cost of each reserve item. These reserve accounts may be waived annually, or less adequate reserves established by a majority of the total voting interests voting in person or by limited proxy at a duly called meeting of the Association. The budget shall include but not be limited to the following items:

1. Common Expense Budget
 - a. Administration of the Association.
 - b. Management fees.
 - c. Maintenance.
 - d. Rent for recreational and other commonly used facilities (if applicable).
 - e. Taxes upon Association property.
 - f. Taxes upon leased areas (if applicable).

- g. Insurance.
 - h. Security provisions.
 - i. Operating capital.
 - j. Reserves.
 - k. Fees payable to the Division of Florida Land Sales, Condominiums and Mobile Homes.
 - l. Other expenses.
2. Proposed assessments against each member, together with annual total assessments.

B. Notice of Proposed Budget. Copies of the proposed budget and proposed assessments shall be hand delivered, mailed or electronically transmitted to each member at least fourteen (14) days prior to the board meeting at which the budget is to be considered, together with a notice of the meeting which shall state the time and place of the meeting. Evidence of compliance with this 14-day notice shall be made by an affidavit executed by an officer or manager of the Association, or other person providing the notice of such meeting, and such affidavit shall be filed among the official records of the association. The board meeting at which the budget is to be considered shall be held at least thirty (30), but not more than ninety (90) days prior to the fiscal year in which the budget is to take effect. The meeting shall be open to all members. If the budget is subsequently amended before the assessments are made, a copy of the amended budget shall be furnished each member.

C. Budget Review. If the Board adopts in any fiscal year an annual budget which requires assessments against Unit Owners which exceed 115 percent of the assessments for the preceding fiscal year, the Board shall conduct a special meeting of the Unit Owners to consider a substitute budget if the Board receives, within 21 days after adoption of the annual budget, a written request for a special meeting from at least 10 percent of all voting interests. The special meeting shall be conducted within 60 days after adoption of the annual budget. At least 14 days prior to such special meeting, the Board shall hand deliver or mail a notice of the meeting. An officer or manager of the Association, or other person providing notice of such meeting shall execute an affidavit evidencing compliance with this notice requirement, and such affidavit shall be filed among the official records of the Association. Unit owners may consider and adopt a substitute budget at the special meeting. A substitute budget is adopted if approved by a majority of all voting interests. If there is not a quorum at the special meeting or a substitute budget is not adopted, the annual budget previously adopted by the board shall take effect as scheduled.

In determining whether assessments exceed 115% of similar assessments in prior years, any authorized provisions for reasonable reserves for repair or replacements of the Condominium Property, expenses by the Association which are not anticipated to be incurred on a regular or annual basis, or assessments for capital improvements to the Condominium Property shall be excluded from the computation. However, as long as the Developer is in control of the board of directors, the board of directors shall not impose an assessment for any year greater than 115% of the prior fiscal or calendar years assessment without approval of a majority of all voting interests of the Association.

9.3 Depository. The depository of the Association shall be such bank or other institution permitted by applicable law, as shall be designated from time to time by the board of directors and from which the monies in such accounts shall be withdrawn only by checks signed by such persons as are authorized by the board of directors.

9.4 Financial Reporting. Within sixty (60) days following the end of the Association's fiscal year, the board of directors shall mail or furnish by personal delivery to each member a complete financial report of actual receipts and expenditures for the previous twelve (12) months. The report shall also be furnished to any Mortgagee upon written request. Upon request from any Mortgagee, the Association shall have prepared and furnish within a reasonable time, an audited financial statement for the preceding fiscal year. The report shall show the amounts of receipts by accounts and receipt classifications and shall show the amounts of expenses by accounts and expense classifications, including, if applicable, but not limited to the following:

- A. Cost for security.
- B. Professional and management fees and expenses.
- C. Taxes.
- D. Cost for recreational facilities.
- E. Expenses for refuse collection and utility services.
- F. Expenses for lawn care.
- G. Cost for building maintenance and repair.
- H. Insurance costs.
- I. Administrative and salary expenses.
- J. General reserves, maintenance reserves and depreciation reserves.

In lieu of sending the financial report to the owners as set forth above, the board of directors shall be permitted to send a complete set of financial statements to the owners within ninety (90) days following the end of the previous fiscal year as permitted under Section 718.111(13), Florida Statutes.

9.5 Fidelity Bonds. The board of directors shall obtain fidelity bonding of all officers and directors who control or disburse funds of the Association, as defined in Section 718.111(11)(d) Florida Statutes and as provided in the Declaration. The amount of such bonds shall be determined in accordance with Section 718.111(11)(d) Florida Statutes and the Declaration. The premiums on such bonds shall be paid by the Association as a common expense.

ARTICLE X
PARLIAMENTARY RULES

Robert's Rules of Order (latest edition) shall govern the conduct of the Association proceedings when not in conflict with the Articles and Bylaws or with the statutes of the state of Florida.

ARTICLE XI
AMENDMENTS

Amendments to the Bylaws shall be proposed and adopted in the following manner:

11.1 Notice. Notice of the subject matter of a proposed amendment shall be included in the notice of any meeting at which a proposed amendment is considered.

11.2 Resolution Approval. An amendment may be proposed by either the board of directors or by the membership of the Association. Except as otherwise provided herein, a resolution adopting a proposed amendment must receive approval of not less than two-thirds (2/3rds) of all the directors until the first election of a majority of directors by Owners other than the Developer. Thereafter, the Bylaws may be amended by not less than two-thirds (2/3rds) of all the directors and by not less than a majority vote of the members of the Association at a duly called meeting of the Association. Notwithstanding any provision herein to the contrary, should Florida Statutes require Owner approval of an amendment, said statute will prevail.

11.3 Recording. An amendment when adopted shall become effective only after being recorded in the Public Records of Alachua County, Florida.

11.4 Developer Rights. At any time prior to the first election of a majority of directors by Owners other than the developer, these Bylaws may be amended by the Developer, if necessary, to make the same consistent with the provisions of the Declaration, to meet the requirements of any governmental entity or statute, and as may be in the best interests of the Association.

11.5 Drafting Requirements. No bylaw shall be revised or amended by reference to its title or number only. Proposals to amend existing bylaws shall contain the full text of the bylaws to be amended; new words shall be inserted in the text underlined, and words to be deleted shall be lined through the hyphens. However, if the proposed change is so extensive that this procedure would hinder rather than assist the understanding of the proposed amendment, it is not necessary to use underlining and hyphens as indicators of words added or deleted, but, instead, a notation must be inserted immediately preceding the proposed amendment in substantially the following language "Substantial rewording of Bylaw. See Bylaw.... for present text." Nonmaterial errors or omissions in the bylaw amendment process shall not invalidate an otherwise properly promulgated amendment.

11.6 Conformance with Declaration. Any amendments to these Bylaws shall be in accord with the terms and provisions of the Declaration which sets forth certain additional voting and approval requirements with respect to certain types of amendments.

ARTICLE XII
SEVERABILITY AND CONFORMITY TO STATE LAW

These Bylaws are to be governed by and construed according to the laws of the State of Florida. If it should appear that any of the provisions hereof are in conflict with the Declaration or any

rule of law or statutory provision of the state of Florida, then such provisions of these Bylaws shall be deemed inoperative and null and void insofar as they may be in conflict therewith, and shall be deemed modified to conform to the Declaration or such rule of law.

ARTICLE XIII
MANDATORY NON-BINDING ARBITRATION

Internal disputes arising from the operation of the Condominium among the Developer, the Association, the Owners, their respective agents and assigns, or any or all of them, must be submitted first for resolution through non-binding arbitration pursuant to Florida law.

ARTICLE XIV
CERTIFICATE OF COMPLIANCE

A certificate of compliance from a licensed electrical contractor or electrician may be accepted by the Association's Board as evidence of compliance of the condominium units with the applicable fire and life safety code.

ARTICLE XV
LIMITED POWER TO CONVEY COMMON ELEMENTS

As provided in Section 718.112(2)(m), Florida Statutes, the Association shall have a limited power to convey a portion of the Common Elements to a condemning authority for the purpose of providing utility easements, right-of-way expansion, or other public purposes, whether negotiated or as a result of eminent domain proceedings.

ARTICLE XVI
MISCELLANEOUS

16.1 Document Availability. The Association shall make available to Unit Owners and Mortgagees for inspection during normal business hours current copies of the Declaration, these Bylaws, the Association Articles of Incorporation, the Condominium Rules and Regulations and other books, records and financial statements of the Association. The Association shall also make available to prospective purchasers of Units current copies of the above-listed documents as well as the most recent annual audited financial statement, if such is prepared.

16.2 Mortgagee Notice. Mortgagees shall be afforded all those notice rights more fully set forth in the Declaration. Such notices shall be provided at Association cost.

CERTIFICATE

The undersigned hereby certifies that he is the duly elected and acting secretary of the Association named herein and that the foregoing is a true copy of the Bylaws of said Association duly adopted by action of the sole Directors dated April 24, 2007, and hereby further certifies that such Bylaws have not been amended or rescinded and remain in full force and effect at the date hereof.

DATED this 24 day of April, 2007.

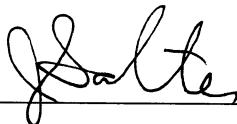

Secretary